

# APPROVAL SHEET

## (RoHS Compliant & Halogen Free)

**CUSTOMER** : 富為電子  
**CUSTOMER'S PART NO.** :  
**DESCRIPTION** : **Multi-layer Chip Diplexer for GPS /WiFi**  
**PART NO.** : **LTD-1608-MKXSM-A1**  
**DATE** : **20200620**  
**AUTHORIZED BY** : *Derek Wei*

	<b>FULLY APPROVED</b>	<b>PARTIALLY APPROVED</b>	<b>REJECTED</b>
<b>SIGN</b>			
<b>SUGGESTION</b>			

美磊科技股份有限公司

**MAG. LAYERS SCIENTIFIC-TECHNICS CO., LTD**

**HEAD OFFICE / PINGZHEN PLANT**

**270, Nan-Feng Road, Pingzhen District, Taoyuan City, Taiwan**

**TEL : 886-3-4159111 FAX : 886-3-4192255**

**[http : //www.maglayers.com.tw](http://www.maglayers.com.tw)**

**[E-mail : info@maglayers.com.tw](mailto:info@maglayers.com.tw)**

## Revision History

Version	Date	Description	Approved by	Prepared by
1	2018/12/06	Initial specification.	CF	Carol
2	2019/03/28	Updated product dimension.	CF	Carol
3	2020/06/05	Update storage condition.	CF	Melody

## ■ APPLICATION

Diplexer for GPS and WiFi application in hand-held device.

## ■ FEATURES

### ■ Compact Size

Miniaturized SMD packaged in low profile and lightweight.

### ■ Low loss

Low insertion loss, high attenuation.

### ■ High Soldering Heat Resistance

High quality termination allows both flow and re-flow soldering methods to be applied.

### ■ Characteristics

Eliminate noise over a wide frequency range. Idea for high frequency and space limited designs.

### ■ Available in tape and reel packaging for automatic mounting

## ■ PRODUCT IDENTIFICATION

L T D - 1 6 0 8 - ### x x - A 1 - □ □  
①                      ②                      ③                      ④                      ⑤

① Product Code

② Dimension Code

③ Series Type (### represents center frequency and xx represents material type)

④ Design Code

⑤ Pattern Code



## ELECTRICAL REQUIREMENTS

Part No.	Item	Frequency Range (MHz)	Insertion Loss (dB)	VSWR	Attenuation (dB)	Isolation (dB)
LTD-1608-MKXSM-A1	Low Band	1550~1580	0.6 max.	2.0 max.	12 min. at 2400~2500 MHz 12 min. at 4900~6000 MHz	20 min. at 1550~1610 MHz 12 min. at 2400~2500 MHz 12 min. at 4900~6000 MHz
		1594~1610	0.7 max.			
	High Band	2400~2500	0.7 max.	2.0 max.	20 min. at 1550~1610 MHz	
		4900~6000	0.6 max.			
	Common	1550~1580	-	2.0 max.	-	-
		1594~1610	-		-	-
		2400~2500	-		-	-
		4900~6000	-		-	-

Operating Temperature Range : -40~85°C

Power Capacity : 3W max.



## PRODUCT DIMENSION

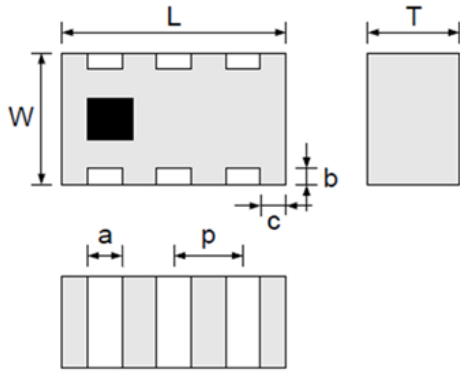

L	W	T	a
1.60±0.15	0.80±0.10	0.60±0.10	0.20±0.10
b	c	p	
0.15±0.10	0.20±0.15	0.50±0.05	

NOTE : Dimensions in mm

## TERMINAL CONFIGURATION

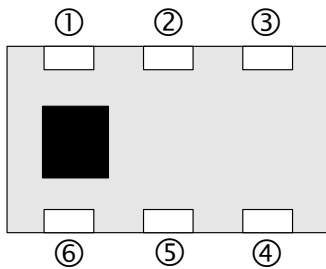

- ① Low Frequency Port
- ② GND
- ③ High Frequency Port
- ④ GND
- ⑤ Common Port
- ⑥ GND

## MEASURING DIAGRAM

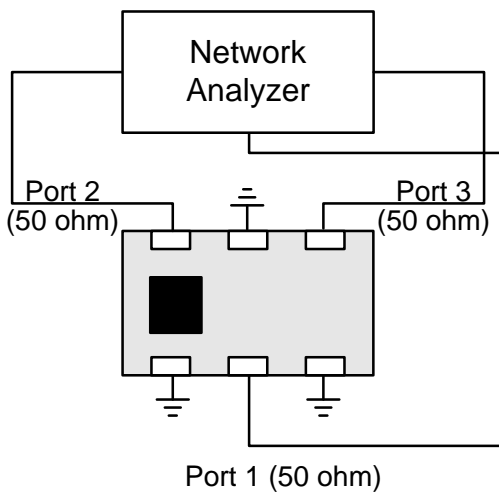

Test Instrument:  
Agilent E5071C Network Analyzer or equivalent.

## RECOMMENDED PCB LAYOUT AND LAND PATTERN

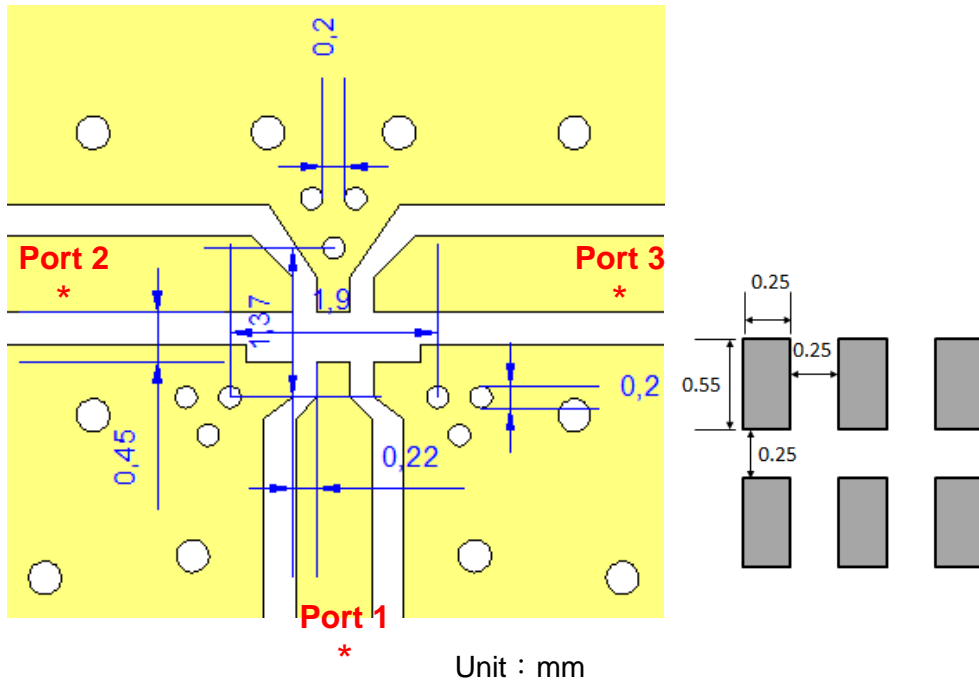

\*Line width should be designed to match 50Ω characteristic impedance, depending on PCB material and thickness.

## ELECTRICAL CHARACTERISTICS ( T=25°C )

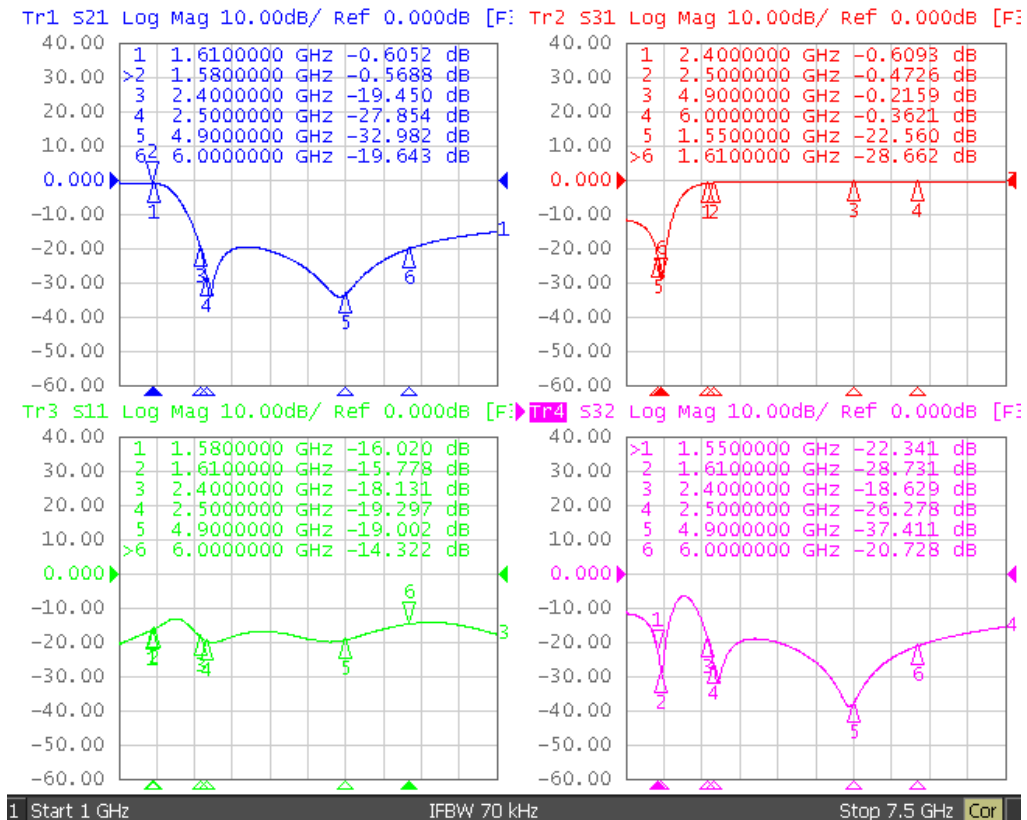

## RELIABILITY TEST

### Mechanical Test

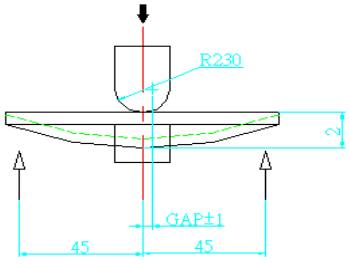
Item	Test Condition	Specification
<b>Vibration</b>	10 Hz/min~55 Hz/min~10 Hz/min vibration frequency with 1.5 mm amplitude for two hours in x, y, z directions	No apparent damage
<b>Drop shock</b>	Dropped onto printed circuit board from 100cm height three times in x, y, z directions. The terminals shall be protected.	No apparent damage
<b>Soldering heat resistance</b>	Preheating temperature : $150\pm 10^{\circ}\text{C}$ Preheating time : 1 to 2 minutes Solder bath temperature : $260\pm 5^{\circ}\text{C}$ Bathing time : $5\pm 0.5$ seconds	No apparent damage
<b>Bending test onto printed circuit board</b>	<p>Solder specimen LTCC components on the test printed circuit board (L: 100 x W: 40 x T: 1.6mm) in appended recommended PCB pattern.</p> <p>Apply the load in direction of the arrow until bending reaches 2 mm.</p>  <p style="text-align: right;">Unit: mm</p>	No apparent damage
<b>Solderability</b>	The dipped surface of the terminal shall be at least 75% covered with solder after dipped in solder bath of $245\pm 5^{\circ}\text{C}$ for $3\pm 0.5$ seconds.	No apparent damage

### Environment Test

<b>Thermal shock</b>	$-40^{\circ}\text{C}$ ~ $85^{\circ}\text{C}$ for 100 cycles each cycle being 30 min	No apparent damage Fulfill the electrical spec. after test
<b>Humidity resistance</b>	$85\pm 2^{\circ}\text{C}$ , 80~90% R.H. for 500 hours	No apparent damage Fulfill the electrical spec. after test
<b>High temperature resistance</b>	$85\pm 2^{\circ}\text{C}$ for 500 hours	No apparent damage Fulfill the electrical spec. after test
<b>Low temperature resistance</b>	$-40\pm 3^{\circ}\text{C}$ for 500 hours	No apparent damage Fulfill the electrical spec. after test



# PACKAGING FOR SMC

## Peel-off force

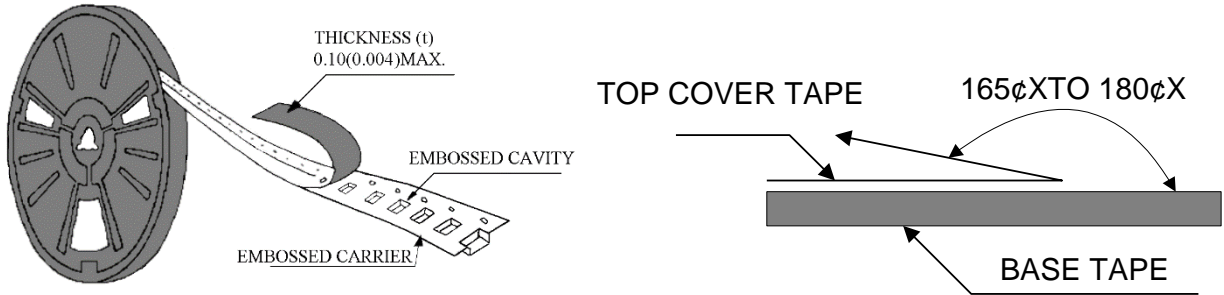

The force for peeling off cover tape is 10 grams in the arrow direction.

## Dimension (Unit: mm)

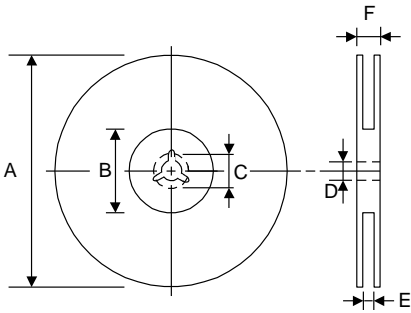

TYPE	A	B	C	D	E	F
8 mm	178±1	60+0.5 -0	-	13±0.2	9±0.5	12±0.5
12 mm	178±0.3	60±0.2	19.3±0.1	13.5±0.1	13.6±0.1	-

## Taping quantity

SERIES	5824 5724	5320 5220	4532	4516	3225	3216 2520	2012 1608	1005
PCS/Reel	5000	3000	1000	2000	2500	3000	4000	10000

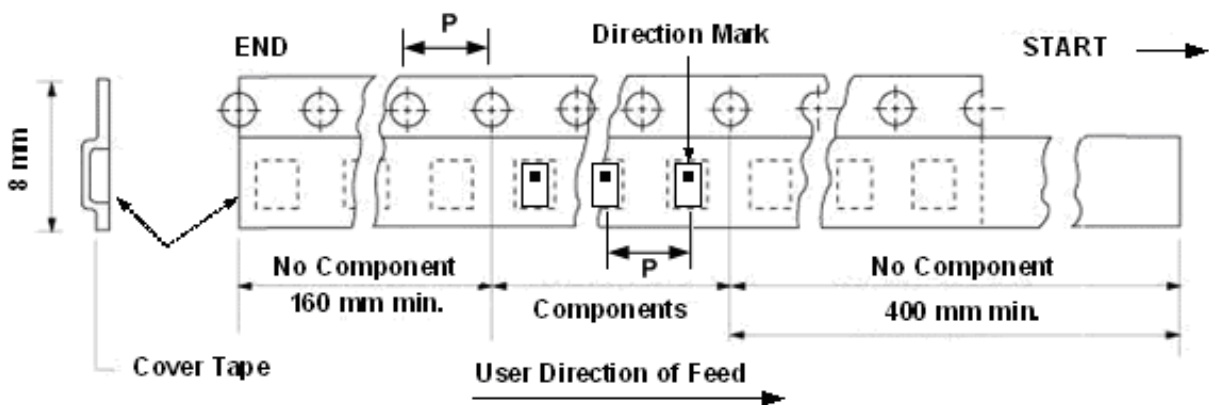

P= 4 mm



## TAPE PACKING CASE

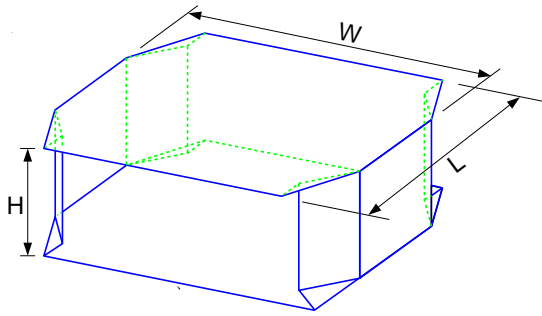

Unit:cm

No. of Reels	W	L	H
2	18±0.5	18±0.5	2.4±0.2
3	18±0.5	18±0.5	3.6±0.2
4	18±0.5	18±0.5	4.8±0.2
5	18±0.5	18±0.5	6.0±0.2

## OPERATION TEMPERATURE

-40°C~85°C

## STORAGE CONDITION

The temperature should be within -40~85°C and humidity should be less than 75% RH. The product should be used within 6 months from the time of delivery.

## ATTENTION REGARDING PCB BENDING

- (a) PCB shall be designed so that products are not subjected to the mechanical stress for board warpage. Product shall be located in the sideways direction to the mechanical stress.

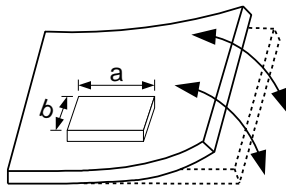

(Poor example)

Length:  $a > b$

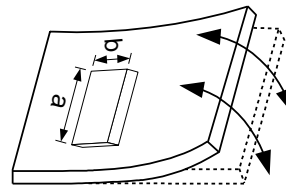

(Good example)

- (b) Products (A,B,C,D) shall be located carefully so that products are not subjected to the mechanical stress due to warping the board. Because they may be subjected to the mechanical stress in order of  $A > C > B \approx D$ .

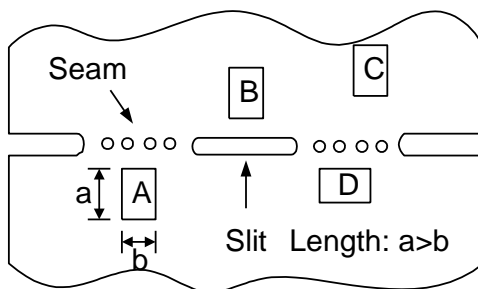

## RECOMMENDED REFLOW SOLDERING PROFILE

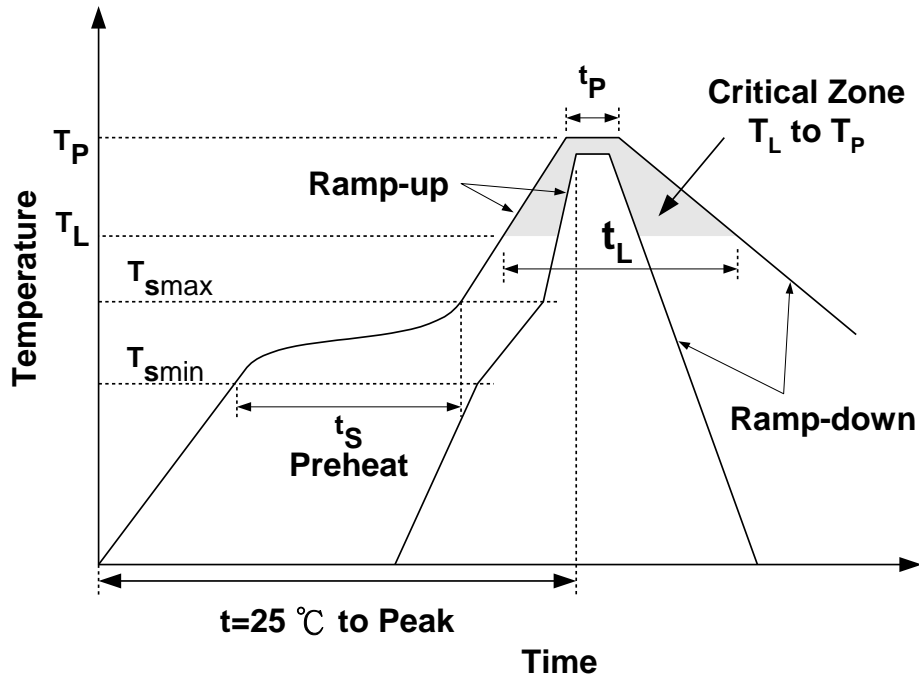

Profile Feature		Sn-Pb	Pb-Free
Preheat	$t_s$	60~120 seconds	60~180 seconds
	$T_{smin}$	100°C	150°C
	$T_{smax}$	150°C	200°C
Average ramp-up rate ( $T_{smax}$ to $T_P$ )		3°C/second max.	3°C/second max.
Time main above	Temperature ( $T_L$ )	183°C	217°C
	Time ( $t_L$ )	60~150 seconds	60~150 seconds
Peak temperature ( $T_P$ )		230°C	250~260°C
Time within 5°C of actual peak temperature ( $t_p$ )		10 seconds	10 seconds
Ramp-down rate		6°C/sec max.	6°C/sec max.
Time 25°C to peak temperature		6 minutes max.	8 minutes max.

## NOTES

The contents of this data sheet are subject to change without notice. Please confirm the specifications and delivery conditions when placing your order.