



# SMxxC Series

## Bi-directional TVS Diodes Array

### SOT-23 Plastic-Encapsulate ESD Protection Diodes

## DESCRIPTION

The SMxxC Series is designed for applications requiring transient overvoltage protection capability. They are intended for use in voltage and ESD sensitive equipment such as computers, printers, business machines, communication systems, medical equipment and other applications. These devices are ideal for situations where board space is at a premium.

This series has been specifically designed to protect sensitive components which are connected to power, data and transmission lines from overvoltage caused by ESD(electrostatic discharge), CDE (Cable Discharge Events),and EFT (electrical fast transients).

## Features

- ◆ 350 Watts Peak Pulse Power per (8/20μs)
- ◆ IEC61000-4-2 (ESD) ±15kV (air), ±8kV (contact)
- ◆ IEC61000-4-4 (EFT) 40A (5/50ns)
- ◆ Protects two bidirectional line
- ◆ Low clamping voltage
- ◆ Low leakage current
- ◆ Working voltages : 3V, 5V, 8V, 12V, 15V, 18V, 20V, 24V, 36V
- ◆ Meets MSL 1 Requirements

## Pin Configuration

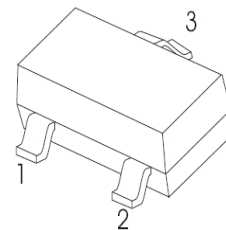

## Circuit Diagram

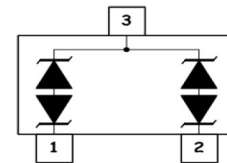

## Applications

- ◆ Cell Phone Handsets and Accessories
- ◆ Microprocessor based equipment
- ◆ Personal Digital Assistants (PDA's)
- ◆ Notebooks, Desktops, and Servers
- ◆ Portable Instrumentation
- ◆ Networking and Telecom
- ◆ Serial and Parallel Ports
- ◆ Peripherals

## Mechanical Characteristics

- ◆ Package: SOT-23
- ◆ Flammability Rating: UL 94V-0
- ◆ High temperature soldering guaranteed: 260 °C/10s
- ◆ Packaging: Tape and Reel

## Absolute Maximum Ratings (T<sub>A</sub>=25°C unless otherwise specified)

Parameter	Symbol	Value	Unit
ESD per IEC 61000-4-2 (Air)	V <sub>ESD</sub>	± 15	KV
ESD per IEC 61000-4-2 (Contact)		± 8	
Peak Pulse Power(tp=8/20us waveform)	P <sub>PP</sub>	350	W
Operating Temperature	T <sub>OPT</sub>	-55 to +150	°C
Storage Temperature	T <sub>STG</sub>	-55 to +150	°C
Lead Solder Temperature – Maximum (10 Second Duration)	T <sub>L</sub>	260(10 sec.)	°C

The above data are for reference only.



# SMxxC Series

## Bi-directional TVS Diodes Array

### Electrical Characteristics (T<sub>A</sub>=25°C unless otherwise specified)

PART NUMBER	DEVICE MARKING	V <sub>RWM</sub> (V) (max.)	V <sub>B</sub> (V) (min.)	I <sub>T</sub> (mA)	V <sub>C@1A</sub> (V) (max.)	V <sub>C</sub> (V)		I <sub>R</sub> (μA) (max.)	C <sub>T</sub> (pF) (max.)
						(max.)	(@A)		
SM03C	C03	3.3	4	1	7.5	13	20	40	450
SM05C	C05	5	6	1	9.8	18	17	10	200
SM08C	C08	8	8.5	1	13.4	24	15	2	120
SM12C	C12	12	13.3	1	19	32	11	1	75
SM15C	C15	15	16.7	1	24	38	10	1	68
SM18C	C18	18	20.0	1	29	45	9	1	57
SM20C	C20	20	22.3	1	35	50	8	1	52
SM24C	C24	24	26.7	1	43	52	7	1	50
SM36C	C36	36	40	1	60	75	4.5	1	35

The above data are for reference only.



**ELECTRICAL CHARACTERISTICS CURVE**

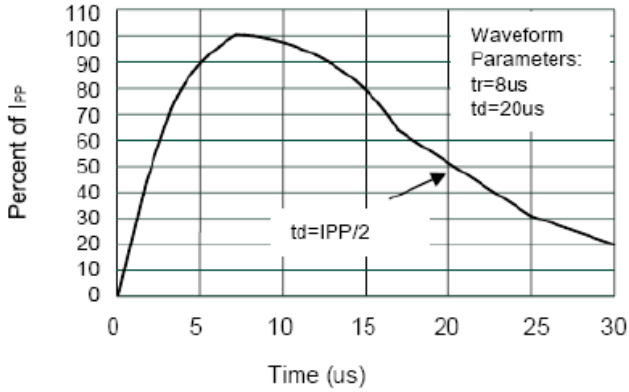

**Pulse Waveform**

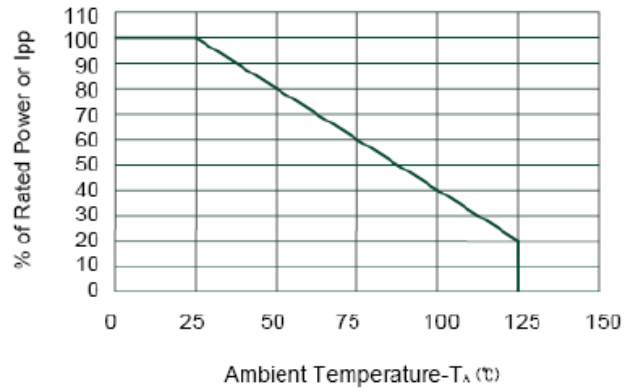

**Power Derating Curve**

The curve above is for reference only.

### Outlitne Drawing

#### SOT-23 Package Outline Dimensions

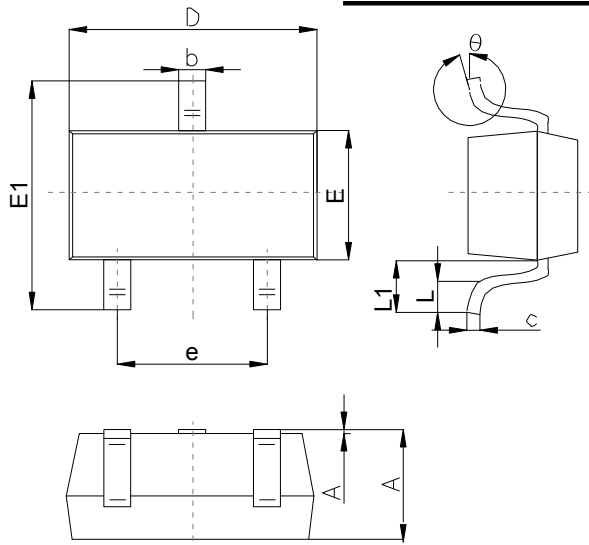

Symbol	Dimensions In Millimeters		
	Min	Typ	Max
A	1.00		1.40
A1			0.10
b	0.35		0.50
c	0.10		0.20
D	2.70	2.90	3.10
E	1.40		1.60
E1	2.4		2.80
e		1.90	
L	0.10		0.30
L1	0.4		
θ	0°		10°

### Suggested Pad Layout

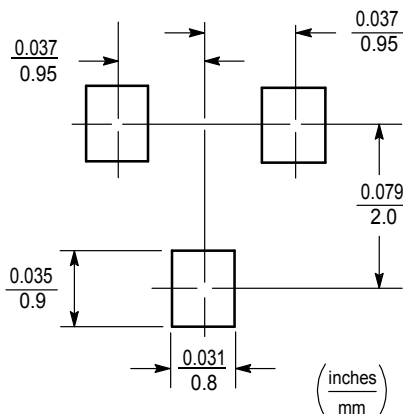

**Note:**

1. Controlling dimension:in/millimeters.
2. General tolerance:  $\pm 0.05\text{mm}$ .
3. The pad layout is for reference purposes only.

### Important Notice and Disclaimer

Microdiode Electronics (Jiangsu) reserves the right to make changes to this document and its products and specifications at any time without notice. Customers should obtain and confirm the latest product information and specifications before final design,purchase or use.

Microdiode Electronics (Jiangsu) makes no warranty, representation or guarantee regarding the suitability of its products for any particular purpose, not does Microdiode Electronics (Jiangsu) assume any liability for application assistance or customer product design. Microdiode Electronics (Jiangsu) does not warrant or accept any liability with products which are purchased or used for any unintended or unauthorized application.

No license is granted by implication or otherwise under any intellectual property rights of Microdiode Electronics (Jiangsu).

Microdiode Electronics (Jiangsu) products are not authorized for use as critical components in life support devices or systems without express written approval of Microdiode Electronics (Jiangsu).



# SMxxC Series

## Bi-directional TVS Diodes Array

### SOT-23 Tape and Reel

#### SOT-23 Embossed Carrier Tape

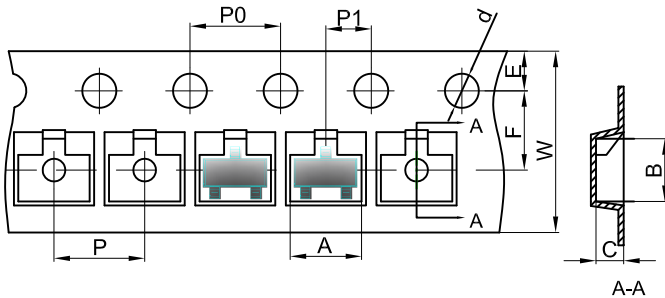

#### Packaging Description:

SOT-23 parts are shipped in tape. The carrier tape is made from a dissipative (carbon filled) polycarbonate resin. The cover tape is a multilayer film (Heat Activated Adhesive in nature) primarily composed of polyester film, adhesive layer, sealant, and anti-static sprayed agent. These reeled parts in standard option are shipped with 3,000 units per 7" or 17.8cm diameter reel. The reels are clear in color and is made of polystyrene plastic (anti-static coated).

Dimensions are in millimeter										
Pkg type	A	B	C	d	E	F	P0	P	P1	W
SOT-23	3.15	2.77	1.22	Ø1.50	1.75	3.50	4.00	4.00	2.00	8.00

#### SOT-23 Tape Leader and Trailer

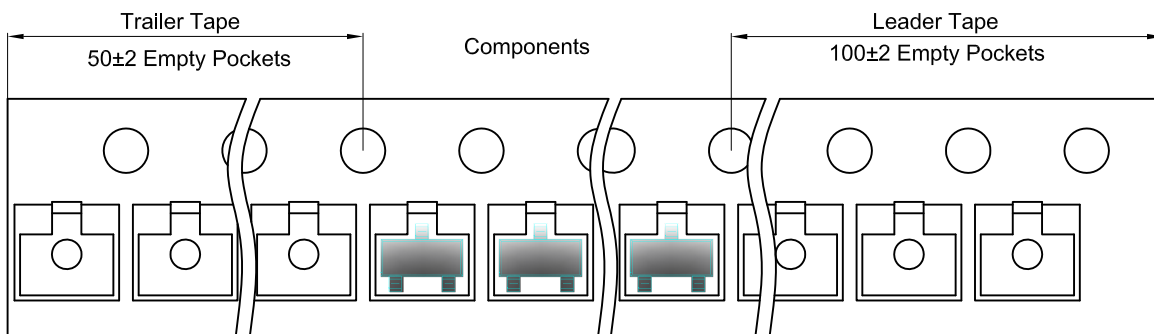

#### SOT-23 Reel

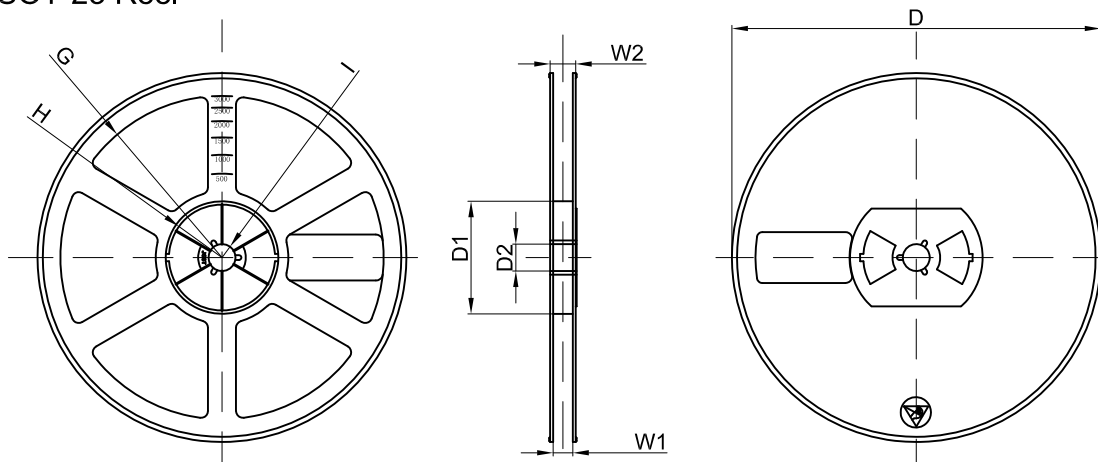

Dimensions are in millimeter								
Reel Option	D	D1	D2	G	H	I	W1	W2
7" Dia	Ø178.00	54.40	13.00	R78.00	R25.60	R6.50	9.50	12.30

REEL	Reel Size	Box	Box Size(mm)	Carton	Carton Size(mm)	G.W.(kg)
3000 pcs	7 Inch	45,000 pcs	203×203×195	180,000 pcs	438×438×220	