

Geofind™ (FR05-S1-E-0-103) – GPS/GLONASS/BeiDou (1561 MHz, 1575 MHz and 1598-1606 MHz)

Fractus Antennas specializes in enabling effective mobile communications. Using Fractus technology, we design and manufacture optimized antennas to make your wireless devices more competitive. Our mission is to help our clients develop innovative products and accelerate their time to market through our expertise in antenna design, testing and manufacturing.

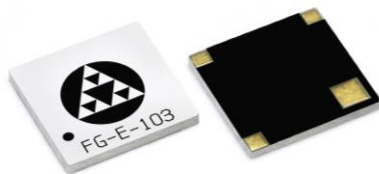

Geofind™

FR05-S1-E-0-103

Fractus Antennas products are protected by [Fractus patents](#).

All information contained within this document is property of Fractus Antennas and is subject to change without prior notice. Information is **provided “as is”** and without warranties. It is prohibited to copy or reproduce this information without prior approval.

Fractus Antennas is an ISO 9001:2015 certified company. All our antennas are lead-free and RoHS compliant.

ISO 9001: 2015 Certified



INDEX OF CHAPTERS

1. ANTENNA DESCRIPTION	4
2. QUICK REFERENCE GUIDE	4
3. ELECTRICAL PERFORMANCE	5
4. MECHANICAL CHARACTERISTICS.....	8
5. MATCHING NETWORK	9
6. ASSEMBLY PROCESS	10
7. PACKAGING	12

TABLE OF CONTENTS

1. ANTENNA DESCRIPTION	4
2. QUICK REFERENCE GUIDE	4
3. ELECTRICAL PERFORMANCE	5
3.1. FRACTUS EVALUATION BOARD	5
3.2. VSWR AND EFFICIENCY	5
3.3. RADIATION PATTERNS, GAIN AND EFFICIENCY	6
3.4. CAPABILITIES AND MEASUREMENT SYSTEMS	7
4. MECHANICAL CHARACTERISTICS	8
4.1. DIMENSIONS AND TOLERANCES	8
4.2. SPECIFICATIONS FOR THE INK	8
4.3. ANTENNA FOOTPRINT (as used in the evaluation board)	9
5. MATCHING NETWORK	9
6. ASSEMBLY PROCESS	10
7. PACKAGING	12

1. ANTENNA DESCRIPTION

The Geofind™ Chip Antenna is specifically engineered for low cost, consumer electronics mobile devices for GPS (1575 MHz), GLONASS (1598-1606 MHz), and BeiDou (1561 MHz).

The Geofind™ Chip Antenna uses space-filling properties of Fractus technology to minimise its size and cost while maintaining a high radiation efficiency value. This monopole antenna performs an omnidirectional radiation pattern, allowing it to work effectively regardless of the position of the GPS/GLONASS/BeiDou device.

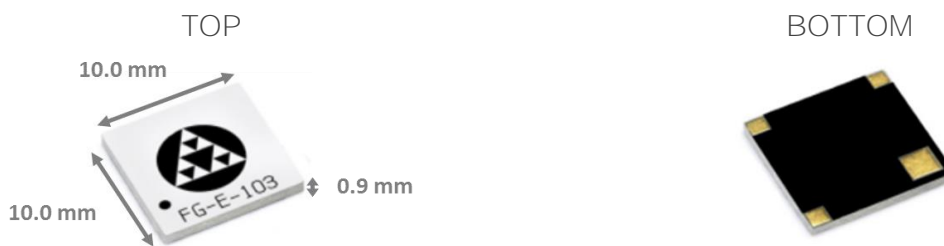

Material: The Geofind™ antenna is built on glass epoxy substrate.

APPLICATIONS

- Metering (Gas, Electricity, Water...)
- RFID (UHF Tags, Readers...)
- Sensors (Parking, Speed control, Optics...)
- Modules Zigbee
- Gateways

BENEFITS

- High efficiency and gain
- Cost-effective
- Small size
- Easy to use (pick and place)

2. QUICK REFERENCE GUIDE

Technical Features	1561 MHz	1575 MHz	1598 – 1606 MHz
Antenna Efficiency	> 75.0 %	> 70.0 %	> 70.0 %
Peak Gain	1.4 dBi	1.2 dBi	1.3 dBi
Radiation Pattern	Omnidirectional		
VSWR	< 2:1		
Polarization	Linear		
Weight (approx.)	0.2 g		
Temperature	-40 to 85° C		
Impedance	50 Ω		
Dimensions (L x W x H)	10.0 mm x 10.0 mm x 0.9 mm		

Table 1 – Technical Features. Measures from the evaluation board. See Figure 1 and picture in page 6.

Please contact info@fractusantennas.com if you require additional information on antenna integration or optimization on your PCB.

3. ELECTRICAL PERFORMANCE

3.1. FRACTUS EVALUATION BOARD

The Fractus Antennas configuration used in testing the Geofind™ Embedded Antenna is displayed in Figure 1.

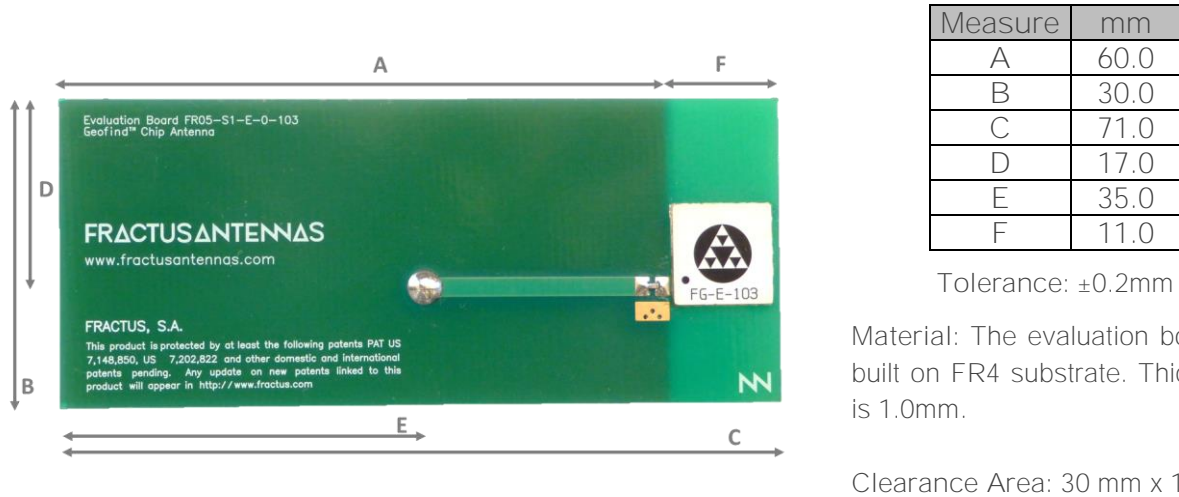

Figure 1 – EB_FR05-S1-E-0-103. Geofind™ Evaluation Board.

3.2. VSWR AND EFFICIENCY

VSWR (Voltage Standing Wave Ratio) and Total Efficiency versus Frequency (GHz).

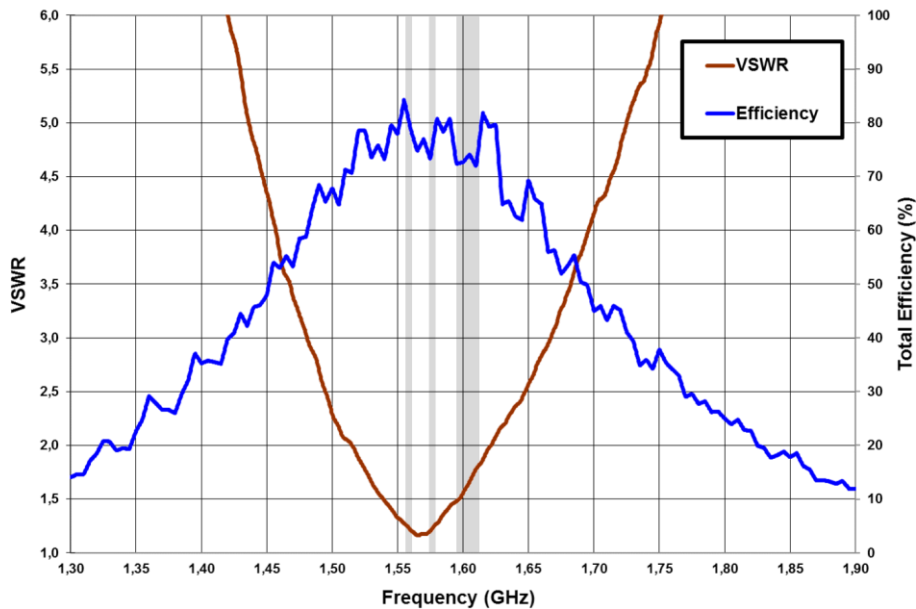
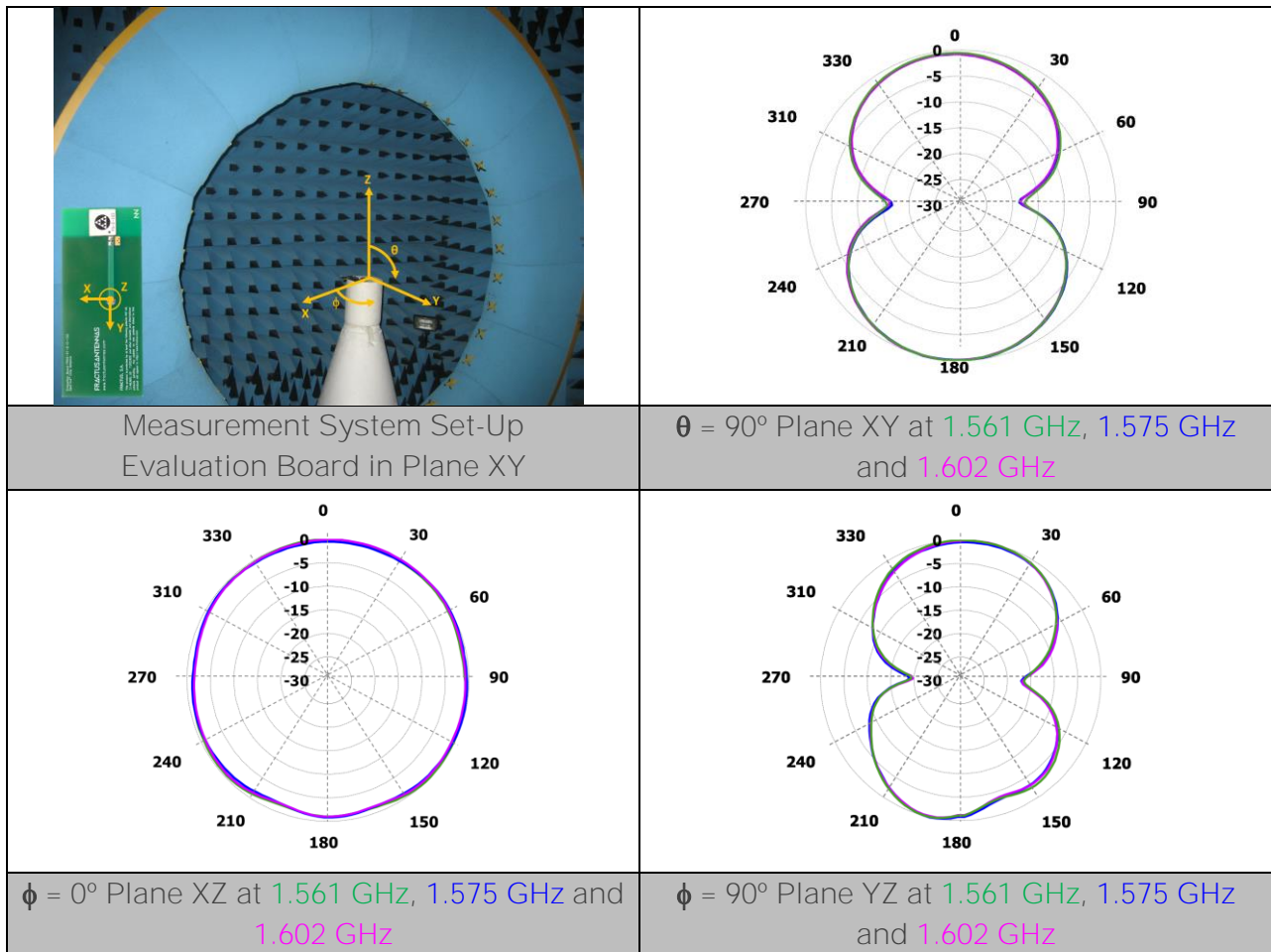

Figure 2 – VSWR and Efficiency (%) vs. Frequency (GHz).

3.3. RADIATION PATTERNS, GAIN AND EFFICIENCY



BeiDou	Gain	1.4 dBi	
	Efficiency	78.0 %	
GPS	Gain	1.2 dBi	
	Efficiency	73.3 %	
GLONASS	Gain	Peak Gain	1.3 dBi
		Average Gain across the band	1.2 dBi
		Gain Range across the band (min, max)	1.2 <-> 1.3 dBi
	Efficiency	Peak Efficiency	73.7 %
		Average Efficiency across the band	73.1 %
		Efficiency Range across the band (min, max)	72.6 – 73.7 %

Table 2 – Antenna Gain and Total Efficiency from the evaluation board (Figure 1) for BeiDou (1561 MHz), GPS (1575 MHz) and GLONASS (1598-1606 MHz) bands. Measures made in the Satimo STARGATE 32 anechoic chamber.

3.4. CAPABILITIES AND MEASUREMENT SYSTEMS

Fractus Antennas specializes in the design and manufacture of optimized antennas for wireless applications, and with the provision of RF expertise to a wide range of clients. We offer turn-key antenna products and antenna integration support to minimize your time requirements and maximize return on investment throughout the product development process. We also provide our clients with the opportunity to leverage our in-house testing and measurement facilities to obtain accurate results quickly and efficiently.

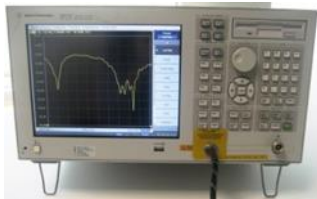

Agilent E5071B

VSWR
&
S Parameters

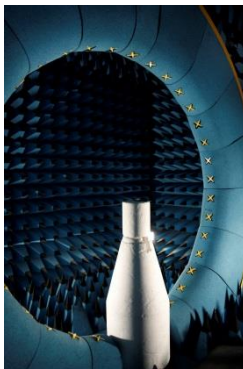
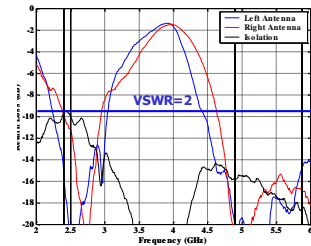

SATIMO STARGATE 32

Radiation
Pattern
&
Efficiency

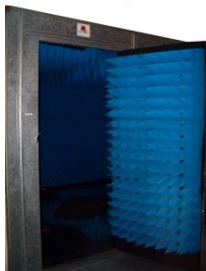
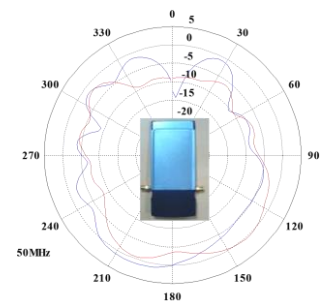

Anechoic chambers and full equipped in-house lab

4. MECHANICAL CHARACTERISTICS

4.1. DIMENSIONS AND TOLERANCES

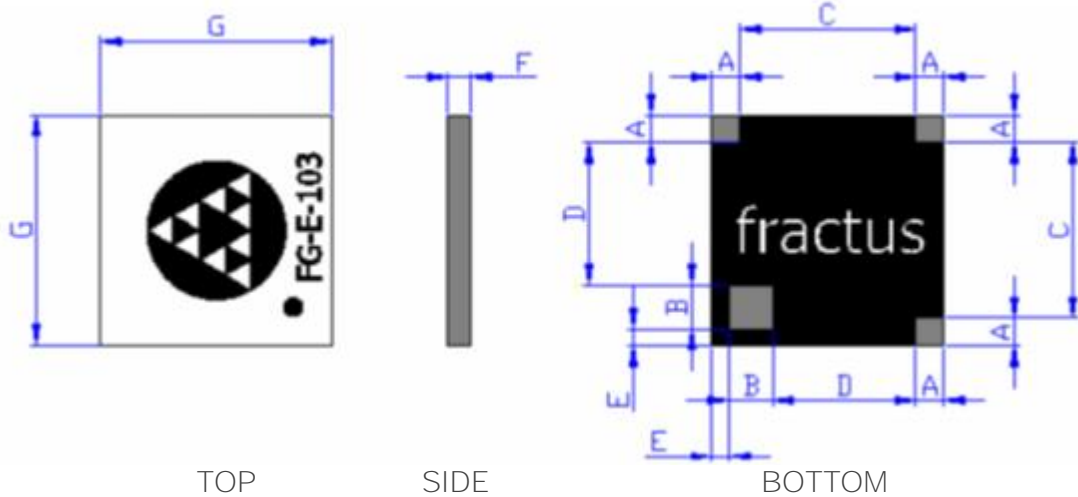

The black dot located on the top side of the antenna indicates the feed pad.

Measure	mm	Measure	mm
A	1.2 ± 0.1	E	0.71 ± 0.15
B	1.9 ± 0.1	F	0.9 ± 0.2
C	7.6 ± 0.2	G	10.0 ± 0.2
D	6.2 ± 0.2		

Figure 3 – Antenna Dimensions and Tolerances.

Fractus Geofind™ chip antenna is compliant with the restriction of the use of hazardous substances (RoHS).

The RoHS certificate can be downloaded from www.fractusantennas.com.

4.2. SPECIFICATIONS FOR THE INK

Next figure shows the correct colors of the antenna:

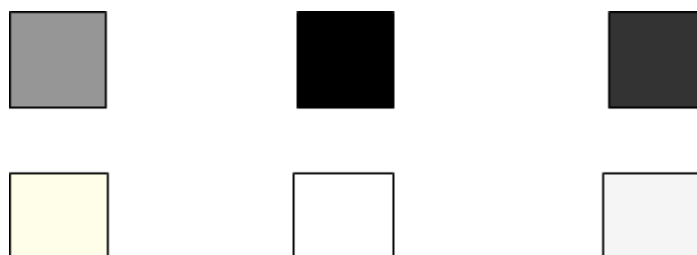

Acceptable color range

4.3. ANTENNA FOOTPRINT (as used in the evaluation board)

This antenna footprint applies for the reference evaluation board described on page 5 of this User Manual.

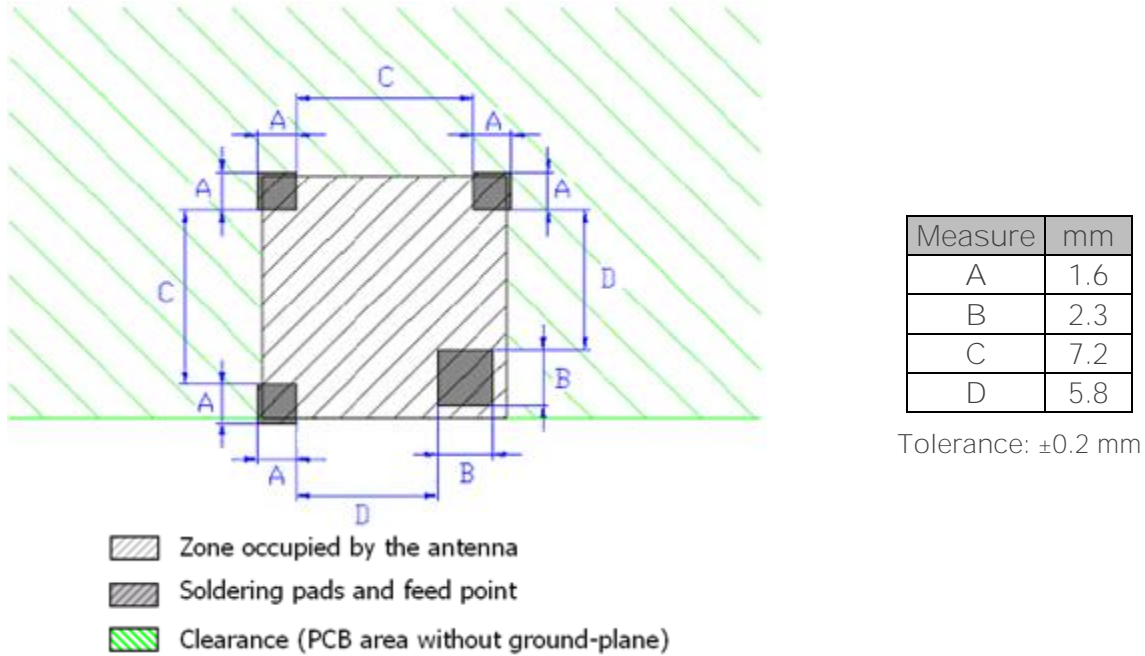

Figure 4 – Antenna Footprint Details.

Other PCB form factors and configurations may require a different feeding configuration, feeding line dimensions and clearance areas. If you require support for the integration of the antenna in your design, please contact info@fractusantennas.com.

5. MATCHING NETWORK

The specs of a Fractus Antennas standard antenna are measured in their evaluation board, which is an ideal case. In a **real design, components nearby the antenna, LCD's, batteries, covers, connectors, etc** affect the antenna performance. This is the reason why it is highly recommended placing pads compatible with 0402 and 0603 SMD components for a PI matching network as close as possible to the antenna feeding point. Do it in the ground plane area, not in the clearance area. This is a degree of freedom to tune the antenna once the design is finished and taking into account all elements of the system (batteries, displays, covers, etc).

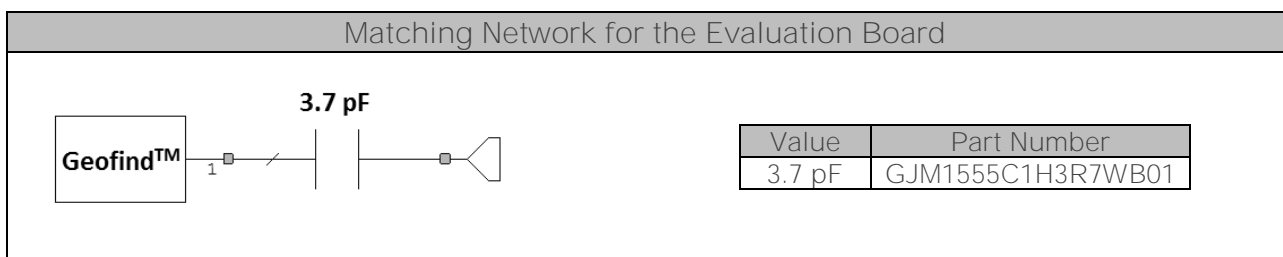

Figure 5 – Matching network implemented in the evaluation Board.

6. ASSEMBLY PROCESS

Figure 6 shows the back and front view of the Geofind™ chip antenna, and indicates the location of the feeding point and the mounting pads:

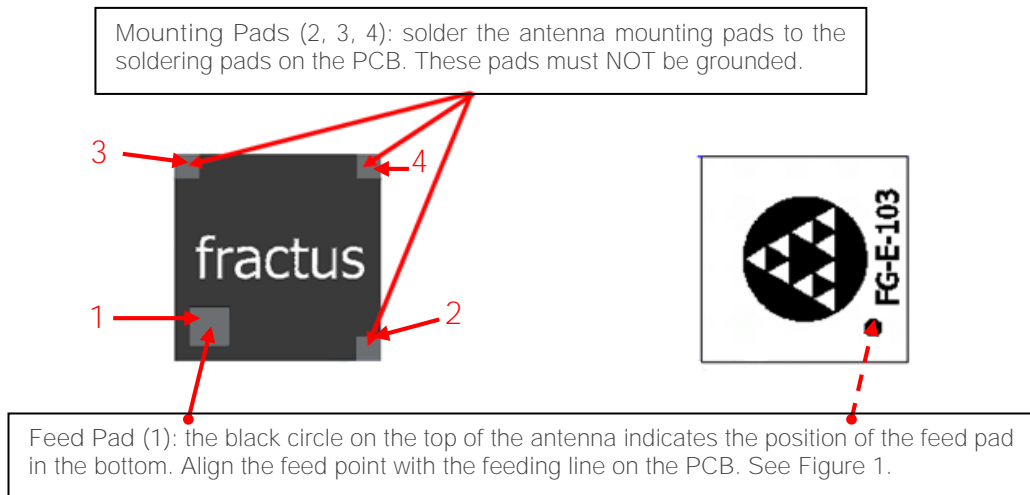

Figure 6 – Pads of the Geofind™ chip antenna.

As a surface mount device (SMD), this antenna is compatible with industry standard soldering processes. The basic assembly procedure for this antenna is as follows:

1. Apply a solder paste to the pads of the PCB. Place the antenna on the board.
2. Perform a reflow process according to the temperature profile detailed in Figure 8 on page 11.
3. After soldering the antenna to the circuit board, perform a cleaning process to remove any residual flux. Fractus Antennas recommends conducting a visual inspection after the cleaning process to verify that all reflux has been removed.

The drawing below shows the soldering details obtained after a correct assembly process:

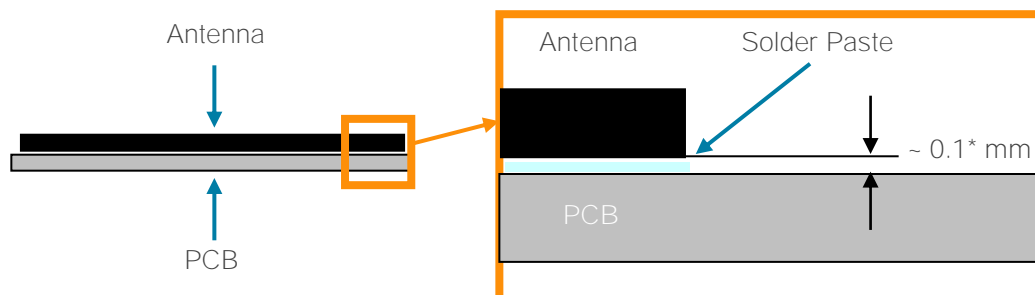

Figure 7 – Soldering Details.

NOTE(*): Solder paste thickness after the assembly process will depend on the thickness of the soldering stencil mask. A stencil thickness equal to or larger than 127 microns (5 mils) is required.

The Geofind™ chip antenna should be assembled following either Sn-Pb or Pb-free assembly processes. According to the Standard IPC/JEDEC J-STD-020C, the temperature profile suggested is as follows:

Phase	Profile features	Pb-Free Assembly (SnAgCu)
RAMP-UP	Avg. Ramp-up Rate (T _{smax} to T _p)	3 °C / second (max.)
PREHEAT	- Temperature Min (T _{smin}) - Temperature Max (T _{smax}) - Time (t _{smin} to t _{smax})	150 °C 200 °C 60-180 seconds
REFLOW	- Temperature (T _L) - Total Time above T _L (t _L)	217 °C 60-150 seconds
PEAK	- Temperature (T _p) - Time (t _p)	260 °C 20-40 seconds
RAMP-DOWN	Rate	6 °C/second max
Time from 25 °C to Peak Temperature		8 minutes max

Table 3 – Recommended soldering temperatures.

Next graphic shows temperature profile (grey zone) for the antenna assembly process in reflow ovens.

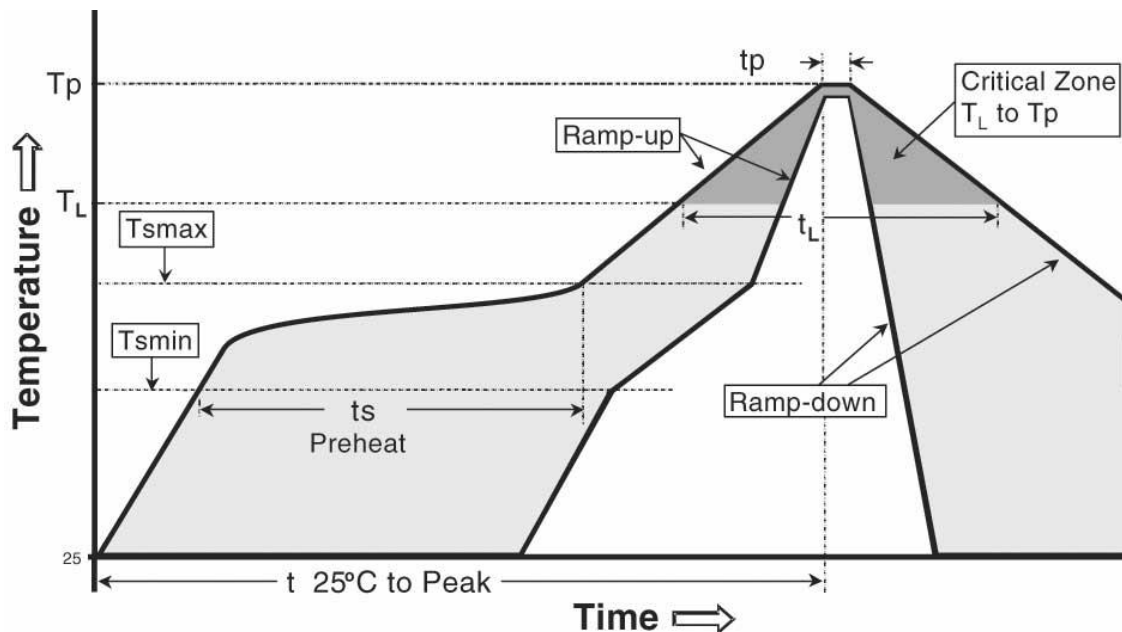

Figure 8 – Temperature profile.

7. PACKAGING

The Geofind™ chip antenna is available in tape and reel packaging.

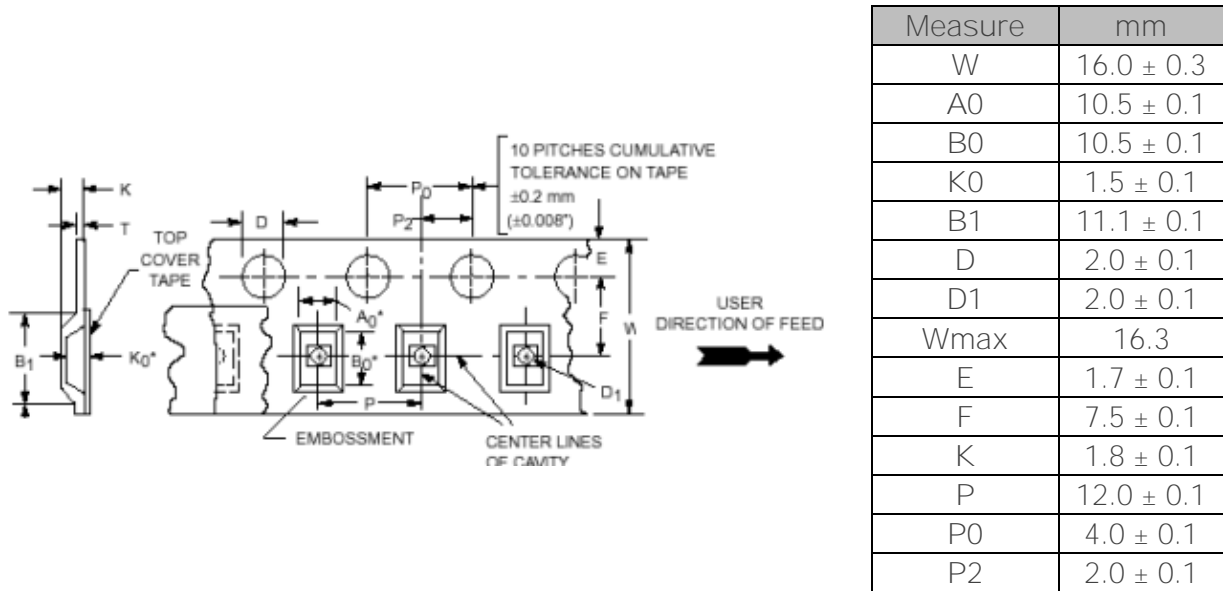
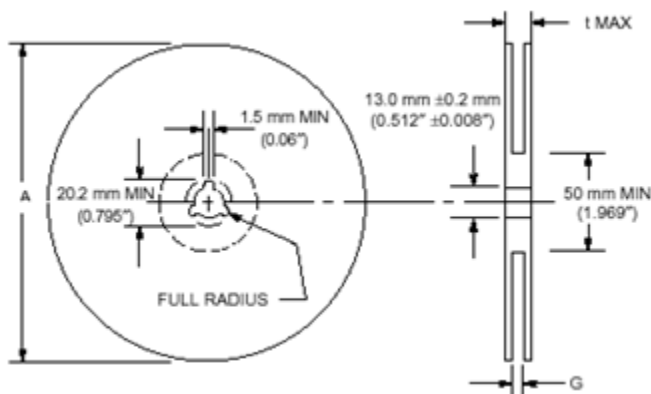

Figure 9 – Tape Dimensions and Tolerances.



Figure 10 – Images of the tape.



Measure	mm
A max	330.0 ± 1.0
G	17.5 ± 0.2
t max	21.5 ± 0.2

Reel Capacity: 2500 antennas

Figure 11 – Reel Dimensions and Capacity.