

DLM11SN900HZ2#

“#” indicates a package specification code.



< List of part numbers with package codes >

DLM11SN900HZ2B DLM11SN900HZ2L

Appearance & Shape

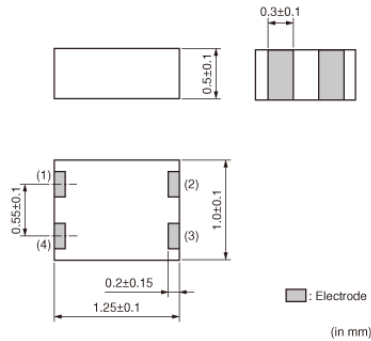

Features

1. Small size and tight dimensional tolerance
Size: 1.25x1.0x0.5mm
Tolerance: ±0.1mm
2. High common mode impedance up to 90ohm (at 100MHz) is available.
3. DLM11S series enables noise suppression for differential signal line without distortion in high-speed signal transmission due to its line impedance matching.
4. High Cut-off Frequency.

Applications

Automotive Usage	Infotainment
------------------	--------------

Packaging Information

Packaging	Specifications	Minimum Order Quantity
B	Bulk(Bag)	500
L	180mm Embossed Tape	4000

Attention

1. This datasheet is downloaded from the website of Murata Manufacturing Co., Ltd. Therefore, its specifications are subject to change or our products in it may be discontinued without advance notice. Please check with our sales representatives or product engineers before ordering.
2. This datasheet has only typical specifications because there is no space for detailed specifications. Therefore, please review our product specifications or consult the approval sheet for product specifications before ordering.

DLM11SN900HZ2#

“#” indicates a package specification code.



Specifications

Shape	SMD	Insulation Resistance(min.)	100MΩ
Size Code (in mm)	1210	Operating Temperature Range	-55°C to 125°C
Size Code (in inch)	0504	Mass(typ.)	0.004g
Length	1.25mm	Number of Circuit	1
Length Tolerance	±0.1mm	Operating Temperature Range(Self-temperature rise is included)	No
Width	1.0mm		
Width Tolerance	±0.1mm		
Thickness	0.5mm		
Thickness Tolerance	±0.1mm		
Common Mode Impedance (at 100MHz)	90Ω		
Common Mode Impedance (at 100MHz) Tolerance	±25%		
Rated Current	100mA		
Derating of Rated Current	No		
Rated Voltage	5Vdc		
Withstanding Voltage	12.5Vdc		
DC Resistance(max.)	1.38Ω		
DC Resistance	1.1Ω±25%		

Attention

1.This datasheet is downloaded from the website of Murata Manufacturing Co., Ltd. Therefore, it's specifications are subject to change or our products in it may be discontinued without advance notice. Please check with our sales representatives or product engineers before ordering.

2.This datasheet has only typical specifications because there is no space for detailed specifications.

Therefore, please review our product specifications or consult the approval sheet for product specifications before ordering.

DLM11SN900HZ2#

“#” indicates a package specification code.

Product Data

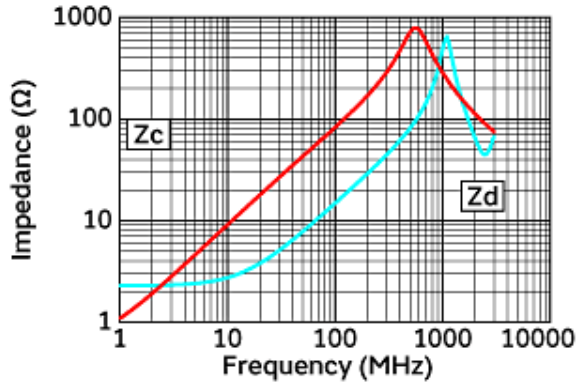

Impedance-Frequency Characteristics

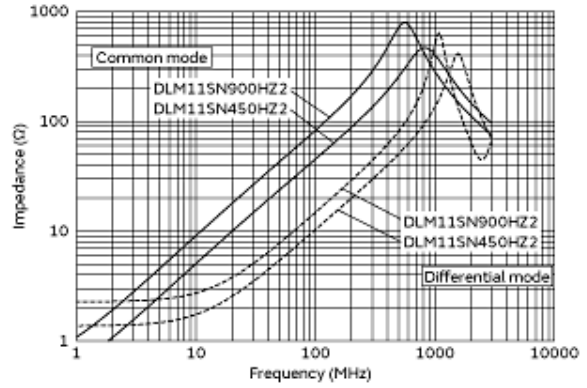

Impedance-Frequency Characteristics (Main Items)

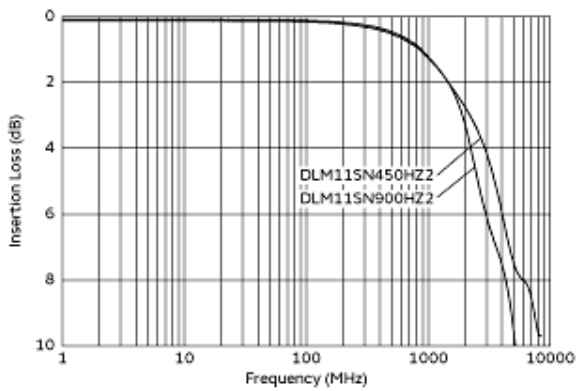

Differential Mode Transmission Characteristics (Typical Value)

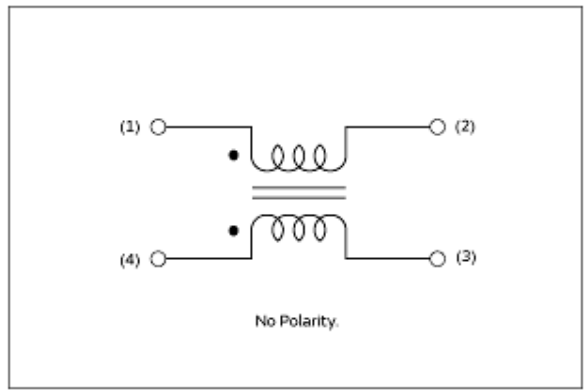

Equivalent Circuit

Attention

- 1.This datasheet is downloaded from the website of Murata Manufacturing Co., Ltd. Therefore, it's specifications are subject to change or our products in it may be discontinued without advance notice. Please check with our sales representatives or product engineers before ordering.
- 2.This datasheet has only typical specifications because there is no space for detailed specifications.
Therefore, please review our product specifications or consult the approval sheet for product specifications before ordering.