

SERIES: P78E-1000 | **DESCRIPTION:** NON-ISOLATED DC SWITCHING REGULATOR

FEATURES

- 1 A of output current
- efficiency up to 96%
- industry standard SIP package
- industrial operating temp -40~+85°C
- designed to meet IEC/EN 62368-1
- drop in equivalent LM78 regulator
- no load input current of 0.2 mA
- output short circuit protection on output



MODEL

MODEL	input voltage ¹		output voltage (Vdc)	output current max (mA)	output power max (W)	ripple & noise ² max (mVp-p)	efficiency ³ typ (%)
	typ (Vdc)	range (Vdc)					
P78E03-1000	24	6~36	3.3	1000	3.3	75	90
P78E05-1000	24	8~36	5	1000	5	75	93
	12	8~27	-5	-500	2.5	75	85
P78E09-1000	24	13~36	9	1000	9	75	94
P78E12-1000	24	16~36	12	1000	12	75	95
	12	8~20	-12	-300	3.6	75	88
P78E15-1000	24	20~36	15	1000	15	75	96
	12	8~18	-15	-300	4.5	75	87

- Notes:
1. For input voltages higher than 30 Vdc, a 22 μ F / 50 V input capacitor is required.
 2. Tested at nominal input, 20~100% load, 20 MHz bandwidth, with 10 μ F electrolytic and 1 μ F ceramic capacitor on the output. At loads below 20%, the max ripple and noise of the 3.3 & 5 Vdc outputs will be 100 mVp-p, and the other outputs will be 2% V_o .
 3. Measured at min V_{in} , full load.
 4. All specifications are measured at $T_a=25^\circ\text{C}$, humidity < 75%, nominal input voltage, and rated output load unless otherwise specified.

PART NUMBER KEY

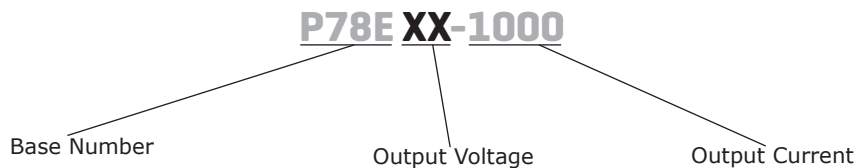

INPUT

parameter	conditions/description	min	typ	max	units
operating input voltage ⁵	for positive output applications	6		36	Vdc
	for negative output applications	8		27	Vdc
filter	capacitor filter				
input reverse polarity protection	no				
no-load input current	positive outputs		0.3	1	mA
	negative outputs		1	4	mA

Note: 5. See Model section on page 1 for specific input voltage ranges.

OUTPUT

parameter	conditions/description	min	typ	max	units
maximum capacitive load ⁶	for positive output applications			680	μF
	for negative output applications			330	μF
voltage accuracy	at full load, input voltage range 3.3 Vdc output model		±2	±4	%
	all other models		±1.5	±3	%
line regulation	at full load, input voltage range		±0.2	±0.4	%
load regulation	at nominal input, 10~100% load positive output applications		±0.4	±0.6	%
	negative output applications		±0.4	±0.8	%
switching frequency	at nominal input voltage, full load		520		kHz
transient recovery time	at nominal input voltage, 25% load step change			1	ms
transient response deviation	at nominal input voltage		±60	±200	mV
temperature coefficient	at full load			±0.03	%/°C

Note: 6. The maximum capacitive load was tested at nominal input voltage, full load.

PROTECTIONS

parameter	conditions/description	min	typ	max	units
short circuit protection	continuous, auto recovery				

SAFETY AND COMPLIANCE

parameter	conditions/description	min	typ	max	units
safety approvals	CE				
conducted emissions	CISPR32/EN55032, class B (external circuit required, see Figure 4/5-b)				
radiated emissions	CISPR32/EN55032, class B (external circuit required, see Figure 4/5-b)				
ESD	IEC/EN61000-4-2, contact ± 4kV, class B				
radiated immunity	IEC/EN61000-4-3, 10V/m, class A				
EFT/burst	IEC/EN61000-4-4, ± 1kV, class B (external circuit required, see Figure 4/5-a)				
surge	IEC/EN61000-4-5, line-line ± 1kV, class B (external circuit required, see Figure 4/5-a)				
conducted immunity	IEC/EN61000-4-6, 3 Vr.m.s, class A				
MTBF	as per MIL-HDBK-217F, 25°C	2,000,000			hours
RoHS	yes				

ENVIRONMENTAL

parameter	conditions/description	min	typ	max	units
operating temperature	see derating curves	-40		85	°C
storage temperature		-55		125	°C
storage humidity	non-condensing			95	%

SOLDERABILITY

parameter	conditions/description	min	typ	max	units
wave soldering	see wave soldering profile			260	°C



MECHANICAL

parameter	conditions/description	min	typ	max	units
dimensions	11.6 x 8.0 x 10.40 [0.457 x 0.315 x 0.409 inch]				mm
case material	black flame-retardant and heat-resistant plastic (UL94 V-0)				
weight			1.9		g

MECHANICAL DRAWING

units: mm [inch]
tolerance: ± 0.50 [± 0.020]
pin diameter tolerance: ± 0.10 [± 0.004]

PIN CONNECTIONS		
PIN	+OUTPUT	-OUTPUT
1	+VIN	+VIN
2	GND	-VOUT
3	+VOUT	GND

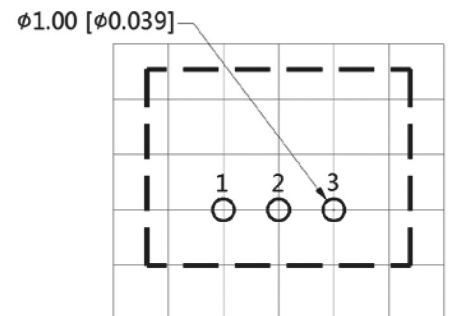
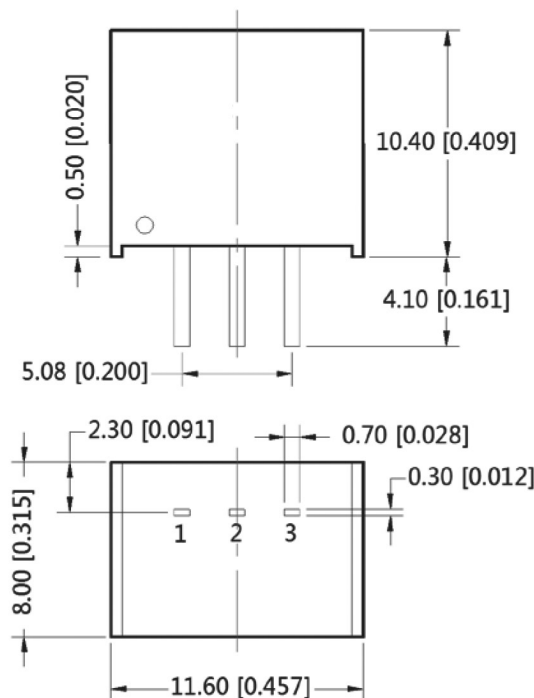

Note : Grid 2.54*2.54mm
Recommended PCB Layout
Top View

DERATING CURVES

Temperature Derating Curves
Positive 3.3, 5 Vdc Outputs
(Natural Convection)

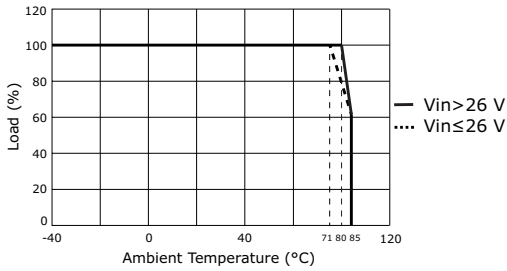

Temperature Derating Curves
Positive 9, 12, 15 Vdc Outputs
(Natural Convection)

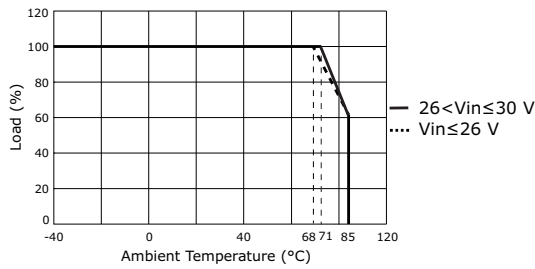

Temperature Derating Curves
Negative Outputs
(Natural Convection)

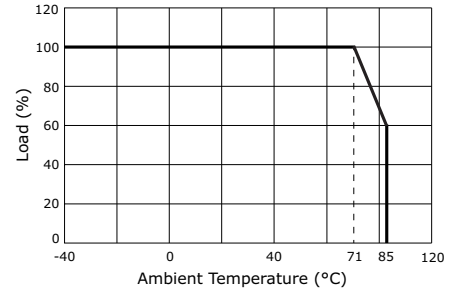

EFFICIENCY CURVES

P78E03-1000 Efficiency Curve
Positive Output, Efficiency vs. Input Voltage
(at full load)

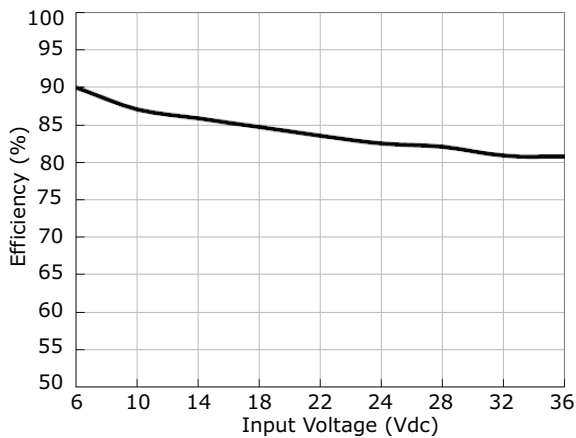

P78E03-1000 Efficiency Curve
Positive Output, Efficiency vs. Load Current
(at Vin nominal)

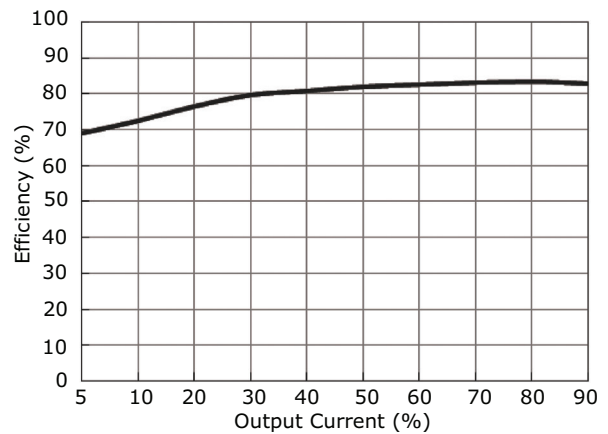

P78E05-1000 Efficiency Curve
Positive Output, Efficiency vs. Input Voltage
(at full load)

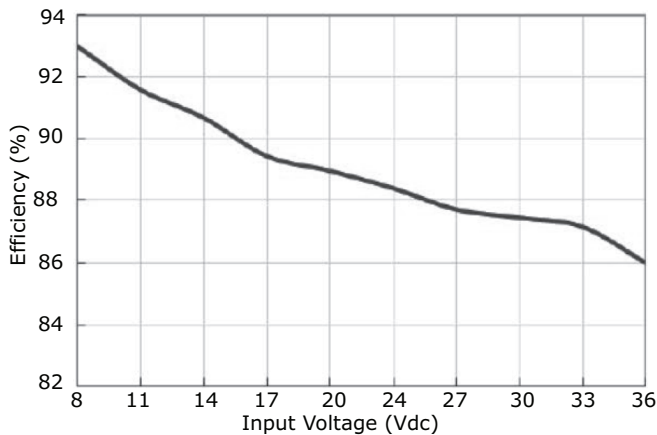

P78E05-1000 Efficiency Curve
Positive Output, Efficiency vs. Load Current
(at Vin nominal)

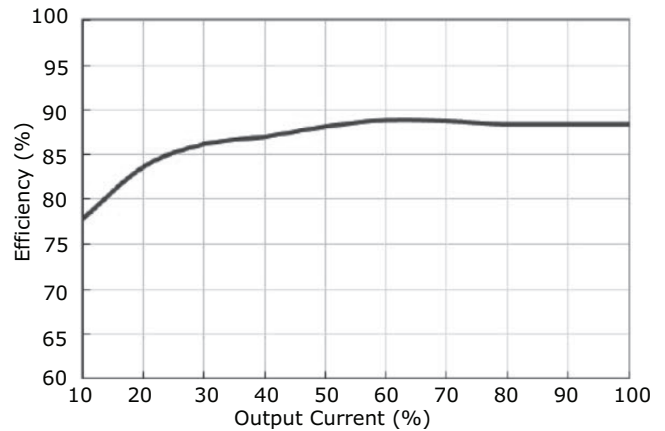

EFFICIENCY CURVES (CONTINUED)

P78E09-1000 Efficiency Curve
Positive Output, Efficiency vs. Input Voltage
(at full load)

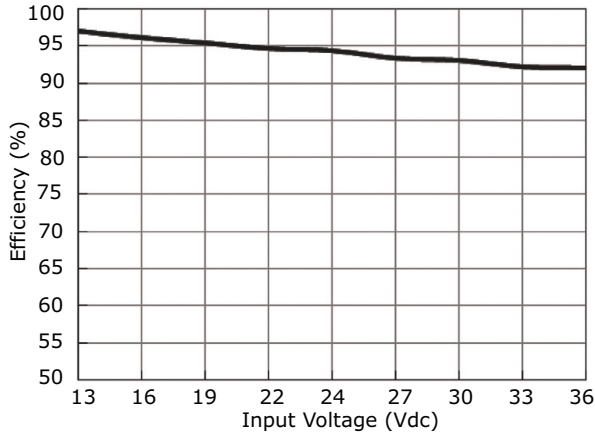

P78E09-1000 Efficiency Curve
Positive Output, Efficiency vs. Load Current
(at Vin nominal)

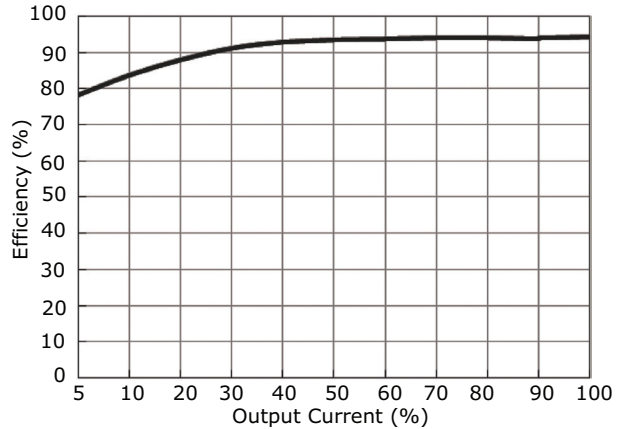

P78E12-1000 Efficiency Curve
Positive Output, Efficiency vs. Input Voltage
(at full load)

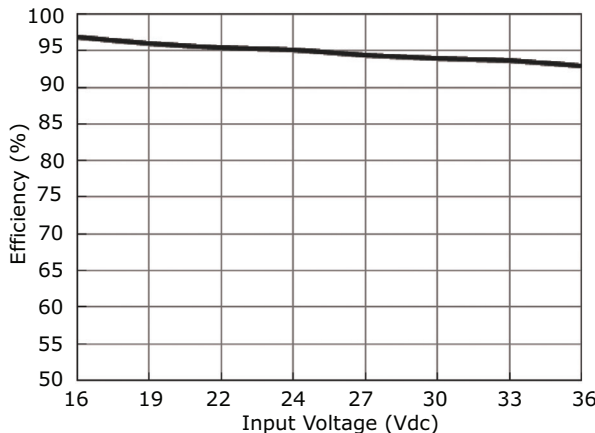

P78E12-1000 Efficiency Curve
Positive Output, Efficiency vs. Load Current
(at Vin nominal)

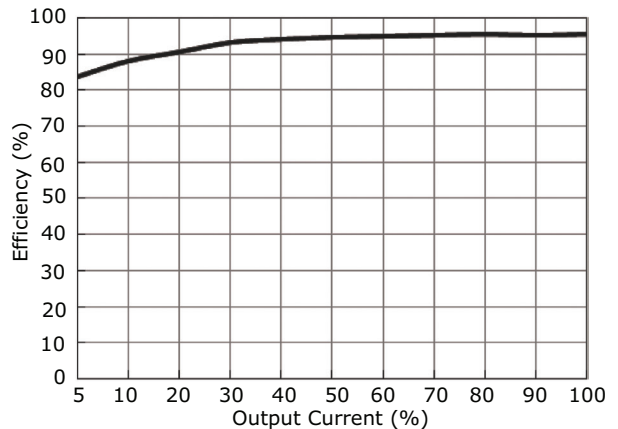

P78E15-1000 Efficiency Curve
Positive Output, Efficiency vs. Input Voltage
(at full load)

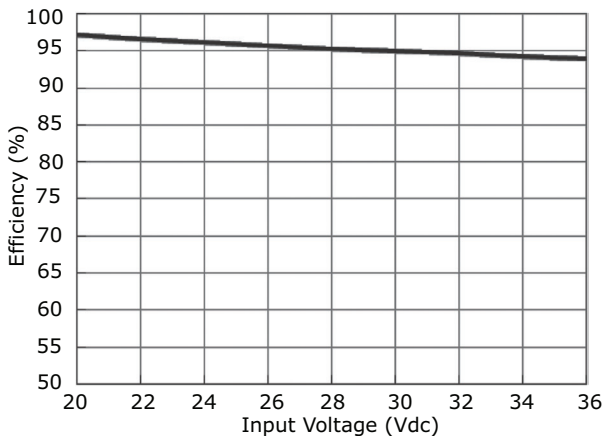

P78E15-1000 Efficiency Curve
Positive Output, Efficiency vs. Load Current
(at Vin nominal)

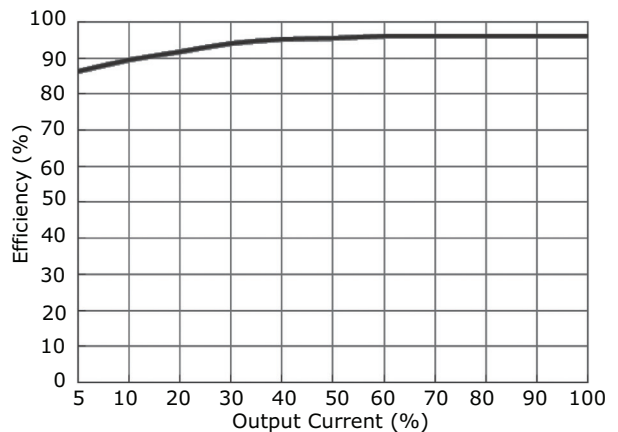

TYPICAL APPLICATION CIRCUIT

Figure 1
Positive Output Application Circuit

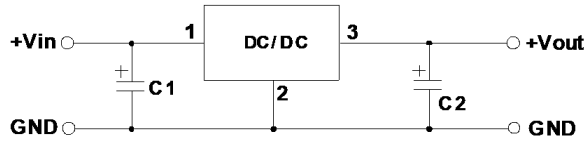

Figure 2
Negative Output Application Circuit

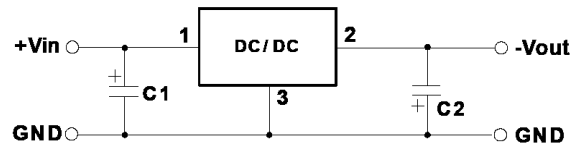

Figure 3
Positive and Negative Output Paralleling Application Circuit

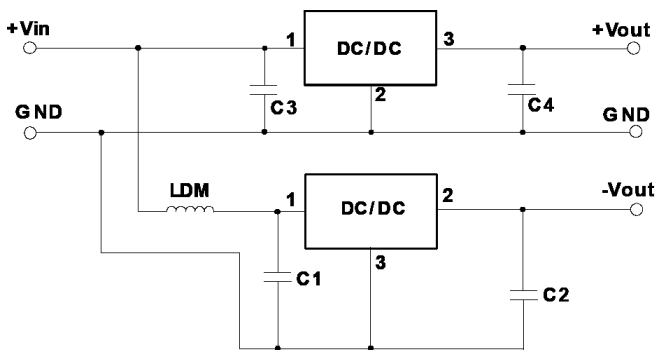

Table 1
External Capacitor Table

Model Number	C1, C3 (ceramic capacitor)	C2, C4 (ceramic capacitor)
P78E03-1000	10 μ F/50 V	22 μ F/10 V
P78E05-1000	10 μ F/50 V	22 μ F/10 V
P78E09-1000	10 μ F/50 V	22 μ F/16 V
P78E12-1000	10 μ F/50 V	22 μ F/25 V
P78E15-1000	10 μ F/50 V	22 μ F/25 V

EMC RECOMMENDED CIRCUIT

Figure 4
Positive output

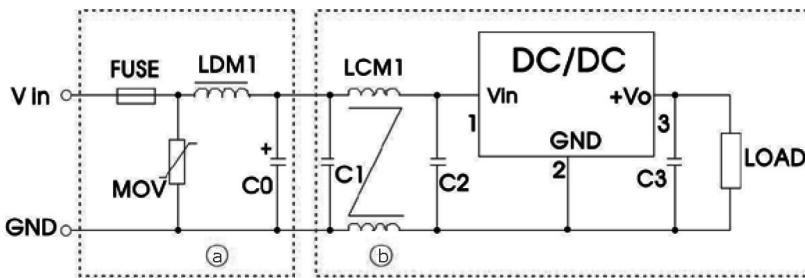

Table 2

Recommended external circuit components	
FUSE	choose according to actual input current
MOV	20D470K
LDM1	82 μ H
C0	680 μ F/50 V
LCM1	4.7 mH
C1, C2	4.7 μ F/50 V
C3	10 μ F/50 V

Figure 5
Negative output

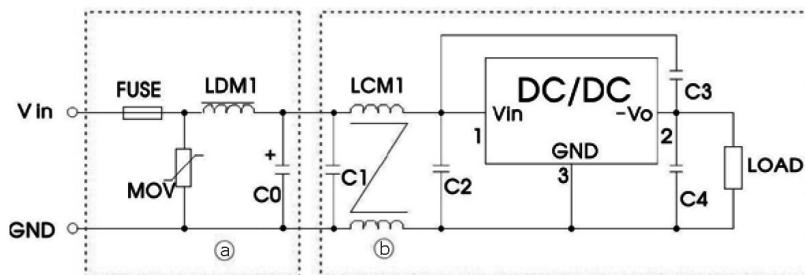

Table 3

Recommended external circuit components	
FUSE	choose according to actual input current
MOV	20D470K
LDM1	82 μ H
C0	680 μ F/50 V
LCM1	4.7 mH
C1, C3, C4	4.7 μ F/50 V
C2	10 μ F/50 V

- Note:
- C1 & C2 (C3 & C4) are required and should be connected as close to the module pins as possible.
 - To reduce the output ripple further, C2 & C4 can be increased as needed and the use of tantalum or low ESR electrolytic capacitors would be recommended.
 - When using application circuit in Figure 3, a 10 μ H LDM component is recommended to reduce the interference.

PACKAGING

units: mm

Tube Size: 9.6 x 16.9 mm

Tube QTY: 43 pcs per tube

Carton Box Size: 285 x 125 x 610 mm

Carton Box QTY: 5,504 pcs per carton box

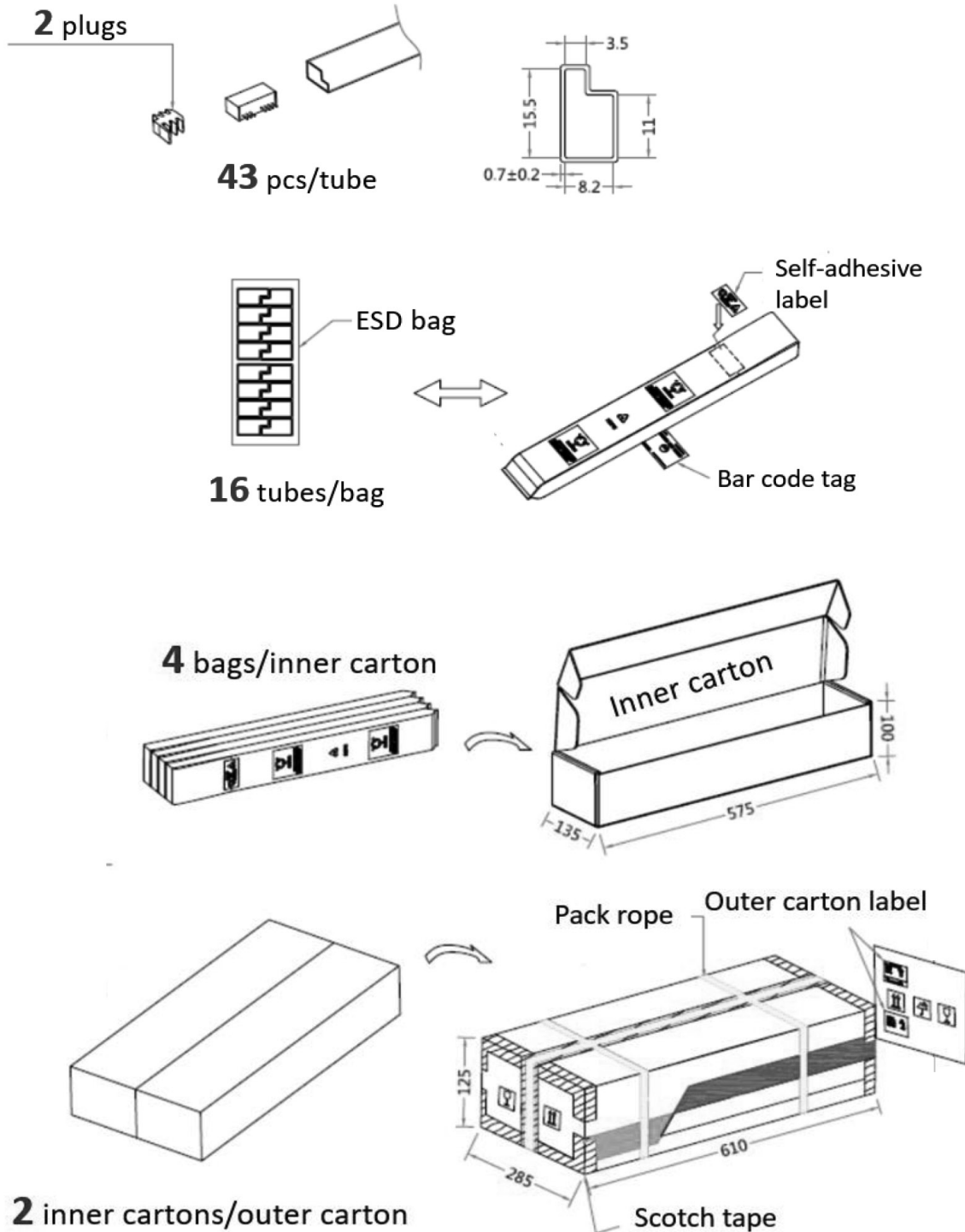

REVISION HISTORY

rev.	description	date
1.0	initial release	09/12/2018

The revision history provided is for informational purposes only and is believed to be accurate.



CUI INC[®]

Headquarters
20050 SW 112th Ave.
Tualatin, OR 97062
800.275.4899

Fax 503.612.2383
cui.com
techsupport@cui.com

CUI offers a two (2) year limited warranty. Complete warranty information is listed on our website.

CUI reserves the right to make changes to the product at any time without notice. Information provided by CUI is believed to be accurate and reliable. However, no responsibility is assumed by CUI for its use, nor for any infringements of patents or other rights of third parties which may result from its use.

CUI products are not authorized or warranted for use as critical components in equipment that requires an extremely high level of reliability. A critical component is any component of a life support device or system whose failure to perform can be reasonably expected to cause the failure of the life support device or system, or to affect its safety or effectiveness.