

This document is the property of Amphenol Corporation and is delivered on the express condition that it is not to be disclosed, reproduced or used, in whole or in part, for manufacture or sale by anyone other than Amphenol Corporation without its prior consent, & that no right is granted to disclose or to use any information in this document.

# CUSTOMER DRAWING

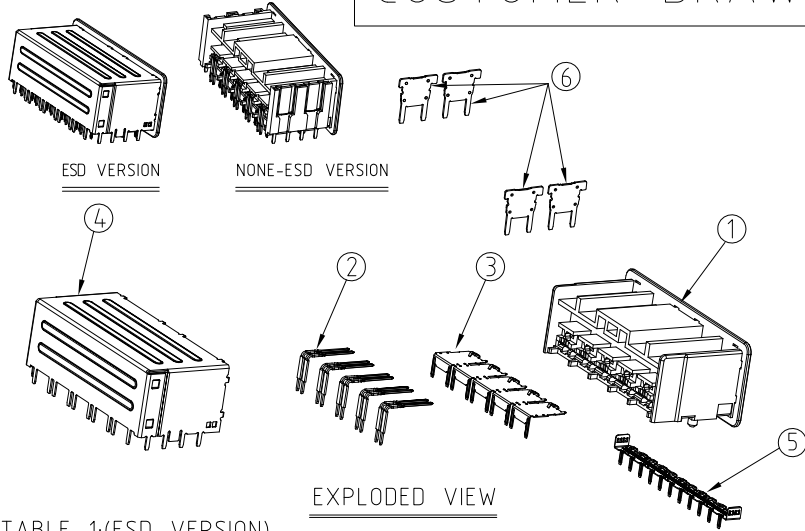

TABLE 1:(ESD VERSION)

ITEM	PART NAME	MATERIAL
①	HOUSING	PA-9T
②	CONTACT	C2680
③	INNER SHELL	C5210
④	OUTER SHELL	C2680
⑤	BOTTOM SHELL	C5210

TABLE 2:(NONE-ESD VERSION)

ITEM	PART NAME	MATERIAL
①	HOUSING	PA-9T
②	CONTACT	C2680
③	INNER SHELL	C5210
⑥	SOLDER TAB	C2680

## 5. ORDER P/N SYSTEM

产品料号编码系统 :NTBM1XR XU011X0X

NO OF ROWS

- 1:SINGLE ROW
- 2:DOUBLE ROW

NO. OF PORT PER ROW

- 1: SINGLE PORT
- 2: 2 PORTS
- 3: 3 PORTS

SHIELDING OPTION

PACKING STYLE

- T-TRAY
- R-TAPE AND REEL

Code Option:

- 1=HOUSING CODE A+CONTACT CARRIER CODE A
- 2=HOUSING CODE B+CONTACT CARRIER CODE A
- 3=HOUSING CODE C+CONTACT CARRIER CODE A
- .....
- 6=HOUSING CODE F+CARRIER CODE A

VERSION	ESD OPTION ESD 选项	INNER SHELL (内部屏蔽壳)	OUTER SHELL (外部屏蔽壳)	BOTTOM SHELL (底部屏蔽壳)	SOLDER TAB (定位焊片)
R0	NONE-ESD	WITHOUT	WITHOUT	WITHOUT	WITH
R1		WITH	WITHOUT	WITHOUT	WITH
R4	ESD	WITH	WITH	WITH	WITHOUT

## NOTES/ 注释:

### 1. MATERIAL/ 材料:

1.1 HOUSING: PA-9T,GF45%,UL94V-0.

胶壳: PA-9T, 玻纤含量45%UL94V-0防火等级.

1.2 CONTACTS/ 端子: C2680/ 黄铜.

PLATING: PLATING 1-2.50um MATTE TIN OVERALL.

电镀规格: 镀全雾锡, 厚度为: 1-2.50微米.

0.76~2.00um MIN NICKEL UNDER PLATED OVERALL.

整体底层镀材为镍层, 厚度为:0.76-2.00微米.

1.3 INNER SHELL: C5210,1~2.50um MATTE TIN PLATED OVERALL,0.76~2.00um NI UNDERPLATED.

内部屏蔽壳: C5210, 镀全雾锡: 1~2.50um, 镍底: 0.76~2.00um.

1.4 OUTER SHELL:C2680R, PLATING SOLDER NI:0.76~2.00um OVERALL,

外部屏蔽壳: C2680R, 镀全可焊镍: 0.76~2.00微米.

1.5 BOTTOM SHELL: C5210,1~2.50um MATTE TIN PLATED OVERALL,0.76~2.00um NI UNDERPLATED.

底部屏蔽壳: C5210, 镀全雾锡: 1~2.50um, 镍底: 0.76~2.00um.

1.6 SOLDER TAB/ 定位焊片: C2680/ 黄铜.

PLATING:1-2.5um MATTE TIN OVERALL. 0.76~2.00um NICKEL UNDER PLATED

### 2. GENERAL SPECIFICATION/ 通用特性:

2.1 CURRENT CONTACT CARRYING CAPACITY MAXIMAL: 3A.

最大可承载电流: 3A

2.2 CONTACT RESISTANCE: 15mΩ MAX.WITH CONDUCTOR CROSS SECTION AREA:0.13MM<sup>2</sup>

接触电阻: 15毫欧最大.导线截面积0.13平方毫米.

2.3 INSULATOR RESISTANCE: 100MΩ MIN.AT Vdc=500V.T=60S

绝缘电阻: 100兆欧最小,施加500V直流电流1分钟

2.4 DIELECTRIC WITHSTANDING VOLTAGE: 500 VAC

耐电压: 500伏交流

2.5 OPERATION TEMPERATURE: -40°C~+105°C

操作温度: 零下40摄氏度至105摄氏度

3. DIMENSIONING SHALL BE INTERPRETED PER ASME Y14.5M 1994.

尺寸标注基于ASME Y14.5M 1994标准规范

4. COMPLIANCE WITH IEEE 100BASE-T1 AND 1000BASE-T1.

符合IEEE 100BASE-T1 AND 1000BASE-T1标准.



UNLESS OTHERWISE SPECIFIED TOLERANCES		APPROVAL		DATE	Amphenol Amphenol East Asia Limited
U.S.	METRIC	DRAWN	Young	07/17'19	
.X	+/- 0.35	CHECKED	DAM	07/17'19	TITLE ETHERNET CONNECTOR, 1X1-1X7 PORTS, INDIRECT, R/A,ESD/NONE-ESD,SOLDER DIP.
.XX	+/- 0.25	CHECKED			
.XXX	+/- 0.10	DRAWING FILE :			SIZE DRAWING NO. A3 NTBM1XR XU011X0X
FRACTIONS	+/- 3°	ANGLE OF PROJECTION			
ANGLES	+/-	DIMENSIONS			REV. 11
FOR MATERIALS AND FINISHES SEE NOTES		U.S. INCHES (METRIC) (MM)			
REMOVE SHARP EDGES		SCALE NONE			SHEET 1 OF 5

This document is the property of Amphenol Corporation and is delivered on the express condition that it is not to be disclosed, reproduced or used, in whole or in part, for manufacture or sale by anyone other than Amphenol Corporation without its prior consent, & that no right is granted to disclose or to use any information in this document.

# CUSTOMER DRAWING

6,60±0,25 TYP.

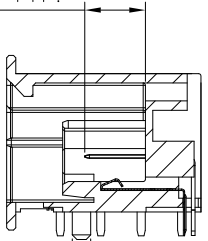

2X $\phi$ 2,00<sup>-0,1</sup>

SECTION A-A

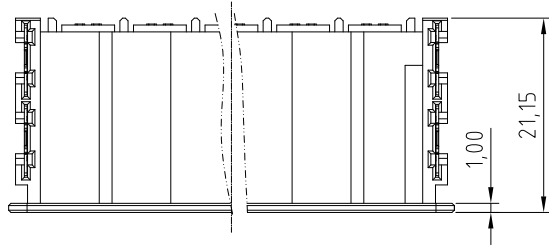

2,60±0,3 TYP.

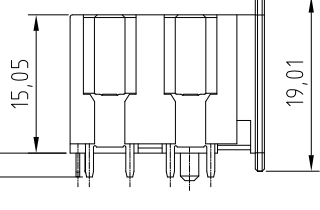

2,25 TYP.

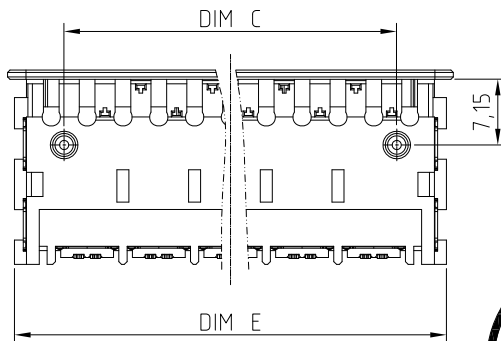
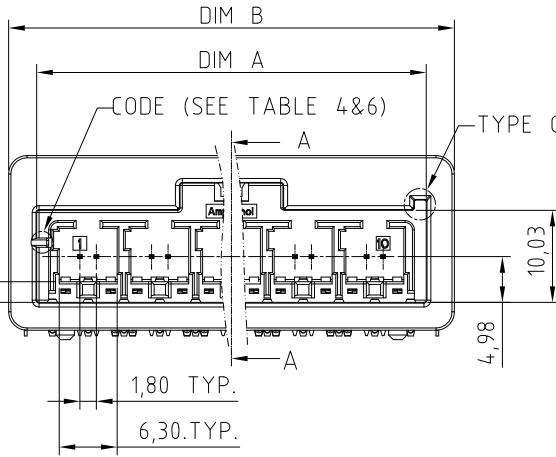

NONE-ESD VERSION SHEET

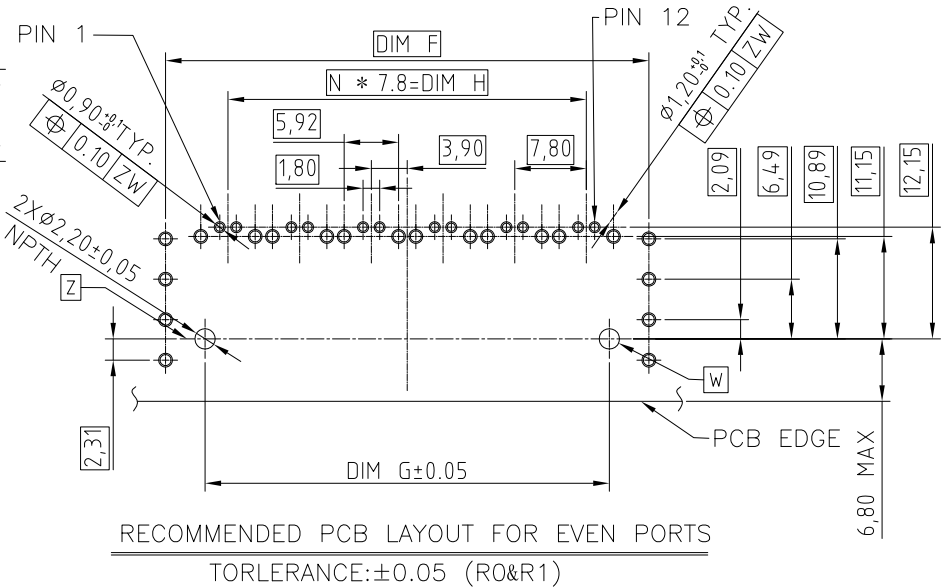
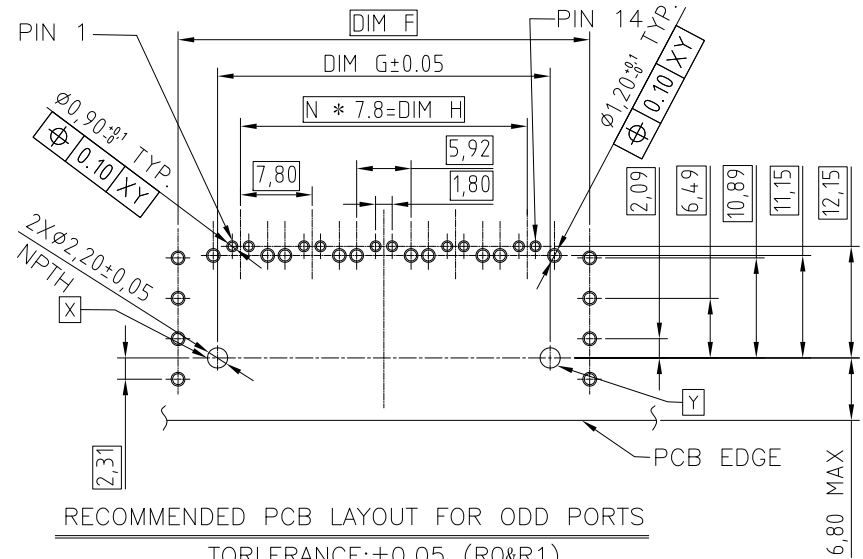

UNLESS OTHERWISE SPECIFIED TOLERANCES	
U.S.	METRIC
.X	+/- 0.35
.XX	+/- 0.25
.XXX	+/- 0.10
FRACTIONS	+/- 3°
ANGLES	+/-

FOR MATERIALS AND FINISHES SEE NOTES

REMOVE SHARP EDGES	
DIMENSIONS	
U.S. (METRIC)	INCHES (MM)

APPROVAL		DATE
DRAWN	Young	07/17'19
CHECKED	DAM	07/17'19
DRAWING FILE :		
ANGLE OF PROJECTION		

Amphenol	
Amphenol East Asia Limited	
TITLE ETHERNET CONNECTOR, 1X1-1X7 PORTS, INDIRECT, R/A,ESD/NONE-ESD,SOLDER DIP.	
SIZE	REV.
A3	11
SCALE	SHEET 2 OF 5

This document is the property of Amphenol Corporation and is delivered on the express condition that it is not to be disclosed, reproduced or used, in whole or in part, for manufacture or sale by anyone other than Amphenol Corporation without its prior consent, & that no right is granted to disclose or to use any information in this document.

# CUSTOMER DRAWING

6,60±0,25 TYP.

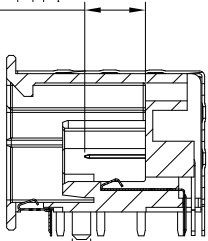

2X $\phi$ 2,00<sup>-0,1</sup>

SECTION A-A

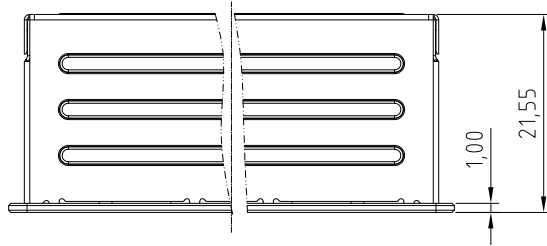

2,60±0,3 TYP.

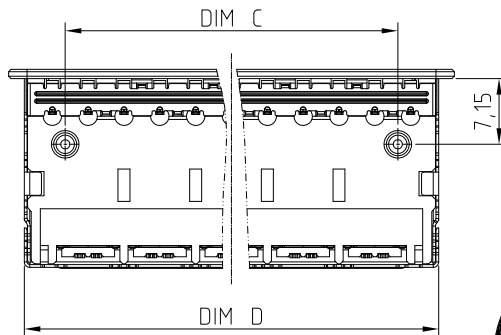
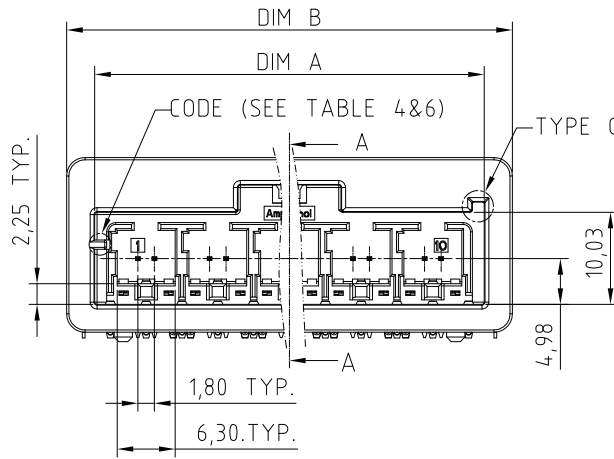
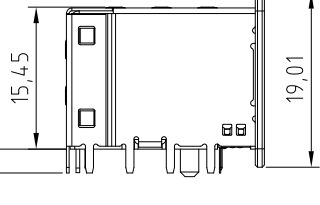

ESD VERSION SHEET

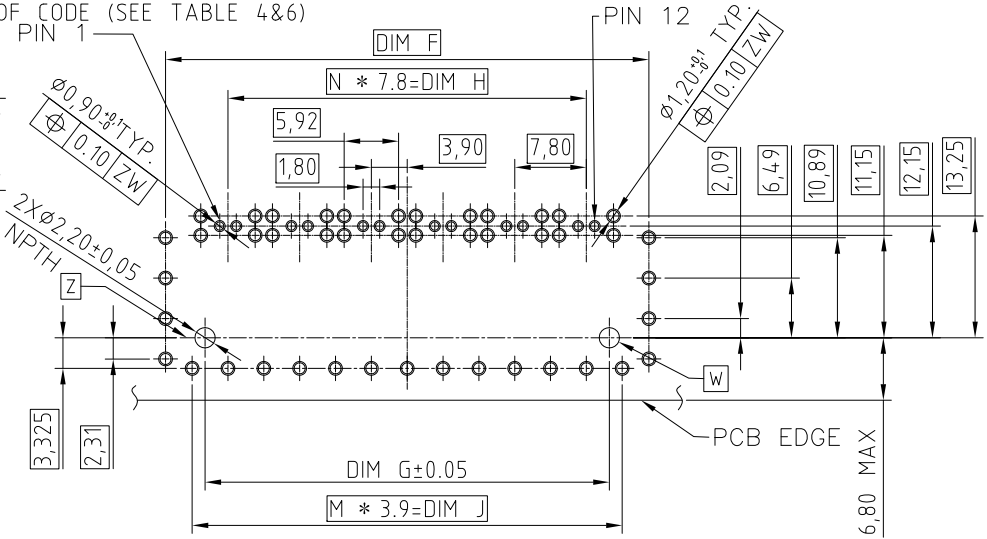
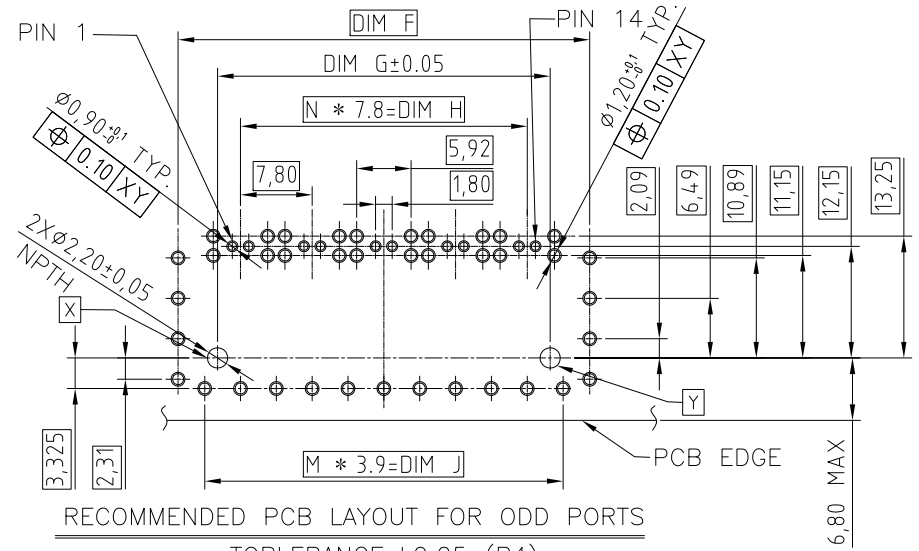

UNLESS OTHERWISE SPECIFIED TOLERANCES	
U.S.	METRIC
.X	+/- 0.35
.XX	+/- 0.25
.XXX	+/- 0.10
FRACTIONS	+/- 3°
ANGLES	+/-

FOR MATERIALS AND FINISHES SEE NOTES

REMOVE SHARP EDGES

DIMENSIONS

U.S.	INCHES
(METRIC)	(MM)

APPROVAL		DATE
DRAWN	Young	07/17'19
CHECKED	DAM	07/17'19
DRAWING FILE :		
ANGLE OF PROJECTION		

Amphenol		Amphenol East Asia Limited
TITLE		
ETHERNET CONNECTOR, 1X1-1X7 PORTS, INDIRECT, R/A,ESD/NONE-ESD,SOLDER DIP.		
SIZE	DRAWING NO.	REV.
A3	NTBM1XRXXU011X0X	11
SCALE	NONE	SHEET 3 OF 5

This document is the property of Amphenol Corporation and is delivered on the express condition that it is not to be disclosed, reproduced or used, in whole or in part, for manufacture or sale by anyone other than Amphenol Corporation without its prior consent & that no right is granted to disclose or to use any information in this document.

# CUSTOMER DRAWING

TABLE 3(DIMENSION FOR DIM"X"):

PORT.	PART NO.	ESD/NONE-ESD	DIM.A	DIM.B	DIM.C	DIM.D	DIM.E	DIM.F	DIM.G	DIM.H	DIM.J	M	N
1X7	NTBM17R4U011X0X	ESD	58.00	64.10	51.80	60.70	/	60.40	51.80	46.80	54.60	14	6
	NTBM17(R0/R1)U011X0X	NONE-ESD	58.00	64.10	51.80	/	62.60	60.40	51.80	46.80	/	/	6
1X6	NTBM16R4U011X0X	ESD	50.20	56.30	44.00	52.90	/	52.60	44.00	39.00	46.80	12	5
	NTBM16(R0/R1)U011X0X	NONE-ESD	50.20	56.30	44.00	/	54.80	52.60	44.00	39.00	/	/	5
1X5	NTBM15R4U011X0X	ESD	42.40	48.50	36.20	45.10	/	44.80	36.20	31.20	39.00	10	4
	NTBM15(R0/R1)U011X0X	NONE-ESD	42.40	48.50	36.20	/	47.00	44.80	36.20	31.20	/	/	4
1X4	NTBM14R4U011X0X	ESD	34.60	40.70	28.40	37.30	/	37.00	28.40	23.40	31.20	8	3
	NTBM14(R0/R1)U011X0X	NONE-ESD	34.60	40.70	28.40	/	39.20	37.00	28.40	23.40	/	/	3
1X3	NTBM13R4U011X0X	ESD	26.80	32.90	20.60	29.50	/	29.20	20.60	15.60	23.40	6	2
	NTBM13(R0/R1)U011X0X	NONE-ESD	26.80	32.90	20.60	/	31.40	29.20	20.60	15.60	/	/	2
1X2	NTBM12R4U011X0X	ESD	19.00	25.10	12.80	21.70	/	21.40	12.80	7.80	15.60	4	1
	NTBM12(R0/R1)U011X0X	NONE-ESD	19.00	25.10	12.80	/	23.60	21.40	12.80	7.80	/	/	1
1X1	NTBM11R4U011X0X	ESD	11.20	17.30	5.00	13.90	/	13.60	5.00	0	7.80	2	0
	NTBM11(R0/R1)U011X0X	NONE-ESD	11.20	17.30	5.00	/	15.80	13.60	5.00	0	/	/	0

TABLE 4: TYPE OF CODE(FOR 1X1 HOUSING ONLY):

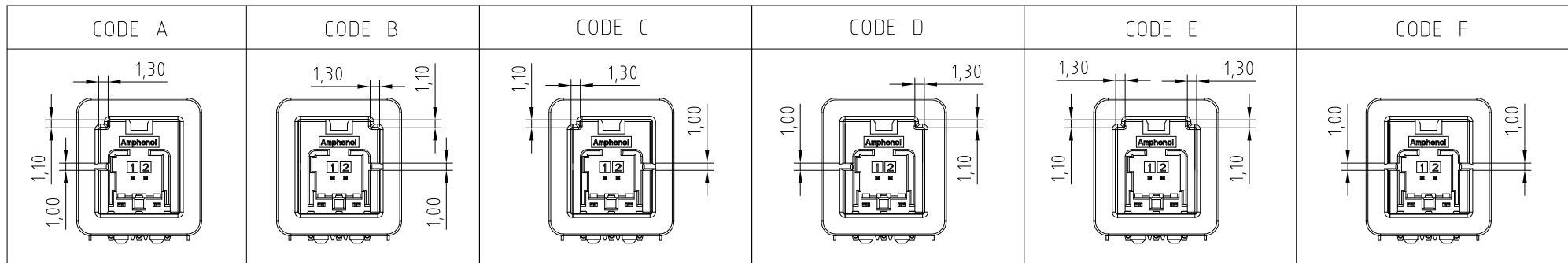

UNLESS OTHERWISE SPECIFIED TOLERANCES		APPROVAL		DATE	
	U.S.	METRIC	DRAWN	Young	07/17/19
.X	+/-	0.35	CHECKED	DAM	07/17/19
.XX	+/-	0.25	CHECKED		
.XXX	+/-	0.10			
FRACTIONS	+/-	3°	DRAWING FILE :		
ANGLES	+/-		ANGLE OF PROJECTION		
FOR MATERIALS AND FINISHES SEE NOTES					
REMOVE SHARP EDGES					
DIMENSIONS					
U.S.	INCHES				
(METRIC)	(MM)				

Amphenol		Amphenol East Asia Limited	
TITLE ETHERNET CONNECTOR, 1X1-1X7 PORTS, INDIRECT, R/A,ESD/NONE-ESD,SOLDER DIP.			
SIZE DRAWING NO.		REV.	
A3	NTBM1XR0U011X0X	11	
SCALE	NONE	SHEET 4 OF 5	

This document is the property of Amphenol Corporation and is delivered on the express condition that it is not to be disclosed, reproduced or used, in whole or in part, for manufacture or sale by anyone other than Amphenol Corporation without its prior consent, & that no right is granted to disclose or to use any information in this document.

# CUSTOMER DRAWING

TABLE 5: (TYPE OF CODE FOR HOUSING 1X2-1X7):

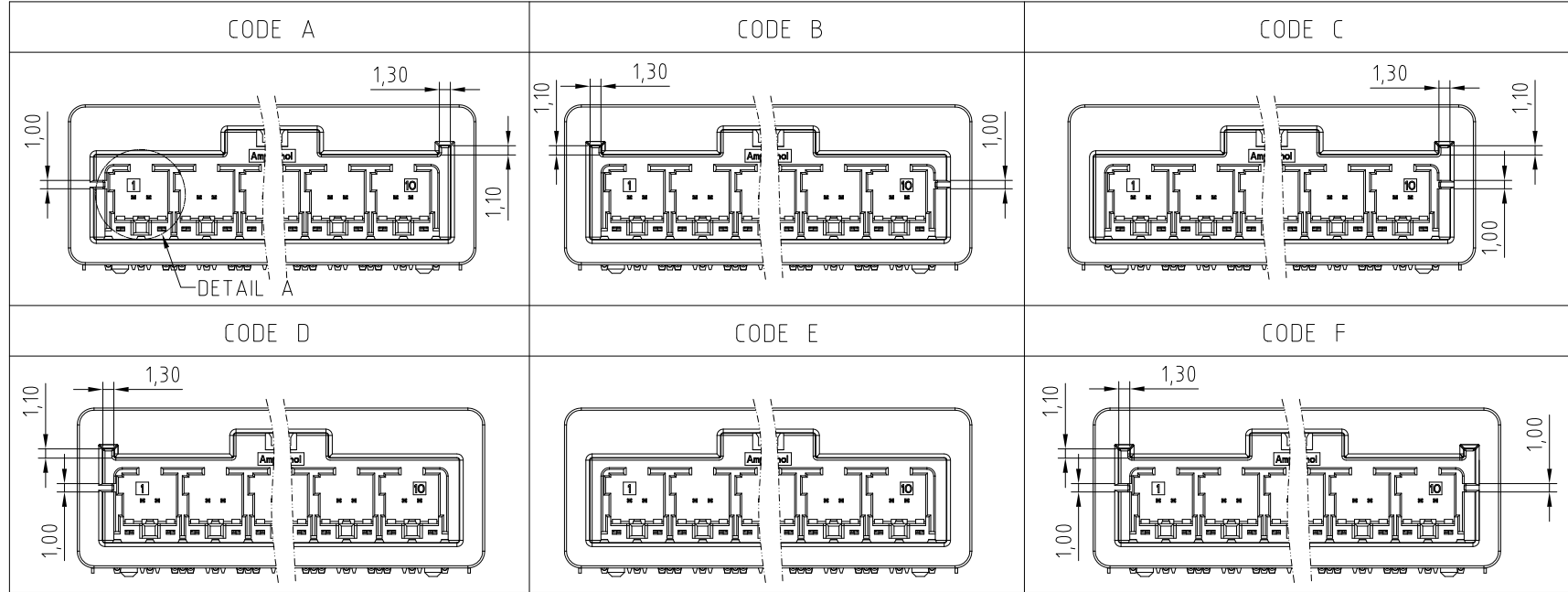
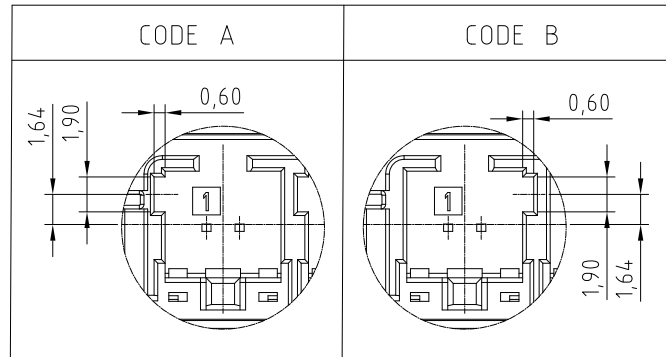

TABLE 7: (COLOR DEFINITION OF CODE FOR HOUSING):

Coding	Color	Ral
A	Black	9005
B	Blue	5005
C	White	9001
D	Claret	4004
E	Green	6002
F	Brown	8011

TABLE 6: (DETAIL A: TYPE OF CODE FOR CONTACT CARRIER CAVITY):



UNLESS OTHERWISE SPECIFIED <b>TOLERANCES</b> U.S. METRIC .X +/- 0.35 .XX +/- 0.25 .XXX +/- 0.10 FRACTIONS +/- ANGLES +/- 3° FOR MATERIALS AND FINISHES SEE NOTES REMOVE SHARP EDGES DIMENSIONS U.S. INCHES (METRIC) (MM)	<b>APPROVAL</b> <b>DATE</b> DRAWN Young 07/17/19 CHECKED DAM 07/17/19 CHECKED		Amphenol Amphenol East Asia Limited
	DRAWING FILE : ANGLE OF PROJECTION 		
	SIZE DRAWING NO. A3 NTBM1XR XU011X0X		REV. 11
	SCALE NONE		SHEET 5 OF 5